

# EMC TEST REPORT For

MAGNIZON POWER SYSTEMS FZE

Big power inverter

Model Number: APS-1012SW-LCD, APS-2012SW-LCD, APS-3012SW-LCD

Prepared for : MAGNIZON POWER SYSTEMS FZE  
Address : JAFZA LB11, 1st floor, Office 32 Jebel ali Free Zone,  
Dubai-UAE PO Box no: 263819

Prepared by : EMTEK (SHENZHEN) CO., LTD.  
Address : Bldg 69, Majialong Industry Zone,  
Nanshan District, Shenzhen, Guangdong, China

Tel: (0755) 26954280  
Fax: (0755) 26954282

Report Number : ES150529358E-3  
Date of Test : June 08, 2015 to August 25, 2015  
Date of Report : June 01, 2016

## TABLE OF CONTENT

Description	Page
<b>1. SUMMARY OF TEST RESULT .....</b>	<b>7</b>
<b>2. GENERAL INFORMATION .....</b>	<b>8</b>
2.1. Description of Device (EUT).....	8
2.2. Description of Support Device.....	8
2.3. Description of Test Facility.....	9
2.4. Measurement Uncertainty .....	9
<b>3. MEASURING DEVICE AND TEST EQUIPMENT .....</b>	<b>10</b>
3.1. For Conducted Emission Measurement.....	10
3.2. For Radiated Emission Measurement.....	10
3.3. For Harmonic Current / Flicker Measurement.....	10
3.4. For Electrostatic Discharge Immunity Test.....	10
3.5. For RF Strength Susceptibility Test .....	11
3.6. For Electrical Fast Transient /Burst Immunity Test.....	11
3.7. For Surge Immunity Test .....	11
3.8. For Injected Current Susceptibility Test.....	11
3.9. For Magnetic Field Immunity Test .....	12
3.10. Low Frequency Signals Test .....	12
<b>4. CONDUCTED EMISSION MEASUREMENT .....</b>	<b>13</b>
4.1. Block Diagram of Test Setup.....	13
4.2. Measuring Standard .....	13
4.3. EUT Configuration on Measurement.....	13
4.4. Operating Condition of EUT .....	13
4.5. Test Procedure .....	14
4.6. Measuring Results.....	14
<b>5. RADIATED EMISSION MEASUREMENT.....</b>	<b>19</b>
5.1. Block Diagram of Test .....	19
5.2. Measuring Standard .....	19
5.3. Radiated Emission Limits .....	19
5.4. EUT Configuration on Test .....	20
5.5. Operating Condition of EUT .....	20
5.6. Test Procedure .....	20
5.7. Measuring Results.....	20
<b>6. HARMONIC CURRENT EMISSION MEASUREMENT .....</b>	<b>25</b>
6.1. Block Diagram of Test Setup.....	25
6.2. Measuring Standard .....	25
6.3. Operation Condition of EUT .....	25
6.4. Measuring Results.....	25
<b>7. VOLTAGE FLUCTUATION AND FLICKER MEASUREMENT.....</b>	<b>29</b>
7.1. Block Diagram of Test Setup.....	29
7.2. Measuring Standard .....	29
7.3. Operation Condition of EUT .....	29
7.4. Measuring Results.....	29
<b>8. IMMUNITY PERFORMANCE CRITERIA DESCRIPTION .....</b>	<b>31</b>
<b>9. ELECTROSTATIC DISCHARGE IMMUNITY TEST .....</b>	<b>33</b>
9.1. Block Diagram of Test Setup.....	33
9.2. Test Standard .....	33

9.3. Severity Levels and Performance Criterion .....	33
9.4. EUT Configuration .....	34
9.5. Operating Condition of EUT .....	34
9.6. Test Procedure .....	34
9.7. Test Results .....	34
<b>10. RF FIELD STRENGTH SUSCEPTIBILITY TEST .....</b>	<b>36</b>
10.1. Block Diagram of Test .....	36
10.2. Test Standard .....	36
10.3. Severity Levels and Performance Criterion .....	37
10.4. EUT Configuration on Test .....	37
10.5. Operating Condition of EUT .....	37
10.6. Test Procedure .....	37
10.7. Test Results .....	38
<b>11. ELECTRICAL FAST TRANSIENT/BURST IMMUNITY TEST .....</b>	<b>40</b>
11.1. Block Diagram of Test Setup .....	40
11.2. Test Standard .....	40
11.3. Severity Levels and Performance Criterion .....	40
11.4. EUT Configuration .....	41
11.5. Operating Condition of EUT .....	41
11.6. Test Procedure .....	41
11.7. Test Result .....	41
<b>12. SURGE IMMUNITY TEST .....</b>	<b>43</b>
12.1. Block Diagram of Test Setup .....	43
12.2. Test Standard .....	43
12.3. Severity Levels and Performance Criterion .....	43
12.4. EUT Configuration .....	44
12.5. Operating Condition of EUT .....	44
12.6. Test Procedure .....	44
12.7. Test Result .....	44
<b>13. INJECTED CURRENTS SUSCEPTIBILITY TEST .....</b>	<b>46</b>
13.1. Block Diagram of Test Setup .....	46
13.2. Test Standard .....	46
13.3. Severity Levels and Performance Criterion .....	46
13.4. EUT Configuration .....	47
13.5. Operating Condition of EUT .....	47
13.6. Test Procedure .....	47
13.7. Test Results .....	47
<b>14. MAGNETIC FIELD SUSCEPTIBILITY TEST .....</b>	<b>49</b>
14.1. Block Diagram of Test .....	49
14.2. Test Standard .....	49
14.3. Severity Levels and Performance Criterion .....	49
14.4. EUT Configuration on Test .....	50
14.5. Test Procedure .....	50
14.6. Test Results .....	50
<b>15. LOW FREQUENCY SIGNALS TEST .....</b>	<b>52</b>
15.1. Block Diagram of Test Setup .....	52
15.2. Test Standard .....	52
15.3. Operating Condition of EUT .....	52
15.4. Test Results .....	52
<b>16. TEST PHOTOGRAPH .....</b>	<b>54</b>
16.1. Photos of Conducted Emission Measurement .....	54
16.2. Photo of Radiation Emission Measurement .....	55
16.3. Photo of Harmonic Measurement .....	56
16.4. Photo of Electrostatic Discharge Test .....	56
16.5. Photo of RF Field Strength susceptibility Test .....	57

16.6. Photos of Electrical Fast Transient /Burst Test.....57  
16.7. Photo of Surge Test.....58  
16.8. Photo of Injected Currents Susceptibility Test.....58  
16.9. Photo of Magnetic Field Immunity Test .....59  
16.10.Photo of Low Frequency Signals Test .....59

APPENDIX (Photos of EUT) (4 Pages)

## TEST REPORT VERIFICATION

Applicant : MAGNIZON POWER SYSTEMS FZE  
Manufacturer : MAGNIZON POWER SYSTEMS FZE  
EUT : Big power inverter  
Trademark : MAGNIZON  
Model Number : APS-1012SW-LCD, APS-2012SW-LCD, APS-3012SW-LCD  
Power Supply : INPUT: 230VAC, 50/60Hz, MAX30A, 1Φ  
OUTPUT: 230VAC, 50/60Hz, MAX10A/20/30A, 1000/2000/3000W  
BATTERY: 12VDC

### Measurement Procedure Used:

EN 62040-2: 2006, IEC 62040-2:2005  
EN 61000-3-2: 2014  
EN 61000-3-3: 2013  
(IEC 61000-4-2:2008, IEC 61000-4-3:2006+A1:2007+A2:2010, IEC61000-4-4:2012,  
IEC 61000-4-5:2005, IEC 61000-4-6:2008, IEC 61000-4-8:2009, IEC 61000-4-11:2004,  
IEC 61000-2-2:2002)

The device described above is tested by EMTEK (SHENZHEN) CO., LTD. to determine the maximum emission levels emanating from the device and the severe levels of the device can endure and its performance criterion. The measurement results are contained in this test report and EMTEK (SHENZHEN) CO., LTD. is assumed full of responsibility for the accuracy and completeness of these measurements. Also, this report shows that the EUT (Equipment Under Test) is technically compliant with the EN 62040-2 requirements.

In this report the model and configuration chosen for each test is representative for all models or configurations (defined in the user manual) by using The "Worst Case" approach of the Guide for the EMC Directive 2014/30/EU.

This report applies to above tested sample only and shall not be reproduced in part without written approval of EMTEK (SHENZHEN) CO., LTD.

Date of Test : June 08, 2015 to August 25, 2015

Prepared by :   
Jessie Hu/Editor

Reviewer :   
Joe Xia/Supervisor\*

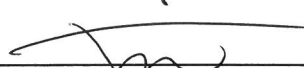
Approved & Authorized Signer :   
Lisa Wang/Manager

## Modified Information

Version	Report No.	Revision Date	Summary
Ver.1.0	ES150529358E	/	Original Report
Ver.1.0	ES150529358E-3	2016-06-01	<ol style="list-style-type: none"><li>1. Change applicant and trademark</li><li>2. Change EUT name and model number</li></ol>

## 1. SUMMARY OF TEST RESULT

<b>EMISSION</b>			
Description of test item	Standard	Limits	Results
Conducted disturbance at mains terminals and Telecommunication Ports	EN62040-2: 2006	C2	Pass
Radiated Disturbance	EN62040-2: 2006	C2	Pass
Harmonic Current Emissions	EN 61000-3-2: 2014	Class A	Pass
Voltage Fluctuation and Flicker	EN 61000-3-3: 2013	Section 5	Pass
<b>Immunity</b>			
Description of test item	Basic Standard	Performance Criteria	Observation Criteria
Electrostatic Discharge (ESD)	IEC 61000-4-2:2008	B	A
Radio-frequency, Continuous radiated disturbance	IEC 61000-4-3:2006+A1:2007+A2:2010	A	A
EFT/B Immunity	IEC61000-4-4:2012	B	B
Surge Immunity	IEC 61000-4-5:2005	B	A
Conducted RF Immunity	IEC 61000-4-6:2008	A	A
Power frequency magnetic field	IEC 61000-4-8:2009	A	A
Voltage dips and Voltage interruptions	IEC 61000-4-11:2004	B	N/A
Low Frequency signals	IEC 61000-2-2:2002	A	A
Note: /			

## 2. GENERAL INFORMATION

### 2.1. Description of Device (EUT)

EUT	:	Big power inverter
Model Number	:	APS-1012SW-LCD, APS-2012SW-LCD, APS-3012SW-LCD (Note: These models are identical in circuitry and electrical, mechanical and physical construction; the only differences are the output electric rating, parts of output component parameters & turns of transformer secondary and model no. For trading purpose. We prepare APS-2012SW-LCD for test.)
Test voltage	:	AC 230V/50Hz, DC 12V
Applicant	:	MAGNIZON POWER SYSTEMS FZE
Address	:	JAFZA LB11, 1st floor, Office 32 Jebel ali Free Zone, Dubai-UAE PO Box no: 263819
Manufacturer	:	MAGNIZON POWER SYSTEMS FZE
Address	:	JAFZA LB11, 1st floor, Office 32 Jebel ali Free Zone, Dubai-UAE PO Box no: 263819
Date of receiver	:	June 08, 2015
Date of Test	:	June 08, 2015 to August 25, 2015

### 2.2. Description of Support Device

N/A : N/A



## 2.3. Description of Test Facility

Site Description

EMC Lab. : Accredited by CNAS, 2013.10.29  
The certificate is valid until 2016.10.28  
The Laboratory has been assessed and proved to be in compliance with CNAS-CL01: 2006 (identical to ISO/IEC17025: 2005)  
The Certificate Registration Number is L2291.

Accredited by TUV Rheinland Guangzhou 2010.5.25  
The Laboratory has been assessed according to the requirements ISO/IEC 17025

Accredited by FCC, April 17, 2013  
The Certificate Registration Number. is 709623.

Accredited by Industry Canada, November 24, 2015  
The Certificate Registration Number. is 4480A

Name of Firm : EMTEK (SHENZHEN) CO., LTD.  
Site Location : Bldg 69, Majialong Industry Zone,  
Nanshan District, Shenzhen, Guangdong, China

## 2.4. Measurement Uncertainty

Test Item	Uncertainty
Conducted Emission Uncertainty	: 3.16dB(9k~150kHz Conduction 2#) 2.90dB(150k-30MHz Conduction 2#)
Radiated Emission Uncertainty (10m Chamber)	: 3.96dB (30M~1GHz Polarize: H) 4.04dB (30M~1GHz Polarize: V)
Uncertainty for Flicker test	: 0.07%
Uncertainty for Harmonic test	: 1.8%
Uncertainty for C/S Test	: 1.45(Using CDN Test)
Uncertainty for R/S Test	: 2.10dB(80MHz-200MHz) 1.76dB(200MHz-1000MHz)
Uncertainty for test site temperature and humidity	: 0.6℃ 4%

### 3. MEASURING DEVICE AND TEST EQUIPMENT

#### 3.1. For Conducted Emission Measurement

Used	Equipment	Manufacturer	Model No.	Serial No.	Last Cal.	Cal. Interval
<input checked="" type="checkbox"/>	L.I.S.N.	ROHDE & SCHWARZ	ESH3-Z6	100011	May 16, 2015	1 Year
<input checked="" type="checkbox"/>	L.I.S.N.	ROHDE & SCHWARZ	ESH3-Z6	100253	May 16, 2015	1 Year
<input checked="" type="checkbox"/>	50Ω Coaxial Switch	Anritsu	MP59B	M20531	May 16, 2015	1 Year
<input checked="" type="checkbox"/>	Pulse Limiter	Rohde & Schwarz	ESH3-Z2	100006	May 16, 2015	1 Year
<input checked="" type="checkbox"/>	L.I.S.N.	ROHDE & SCHWARZ	ESH3-Z6	100011	May 16, 2015	1 Year

#### 3.2. For Radiated Emission Measurement

Used	Equipment	Manufacturer	Model No.	Serial No.	Last Cal.	Cal. Interval
<input checked="" type="checkbox"/>	EMI Test Receiver	Rohde & Schwarz	ESCI	101045	May 16, 2015	1 Year
<input checked="" type="checkbox"/>	Pre-Amplifier	CDIL	PAP-0203	22013	May 16, 2015	1 Year
<input checked="" type="checkbox"/>	Bilog Antenna	Schwarzbeck	VULB9163	143	May 16, 2015	1 Year
<input checked="" type="checkbox"/>	Cable	H+B	CBL3-MN-0.5m	100319-2140500-1	May 16, 2015	1 Year
<input checked="" type="checkbox"/>	Cable	H+B	CBL3-NN-3m	100319-2143000-1	May 16, 2015	1 Year
<input checked="" type="checkbox"/>	Cable	H+B	CBL3-MN-6.5m	100319-2146500-1	May 16, 2015	1 Year
<input checked="" type="checkbox"/>	Cable	H+B	CBL3-NN-10.5m	100319-21410500	May 16, 2015	1 Year
<input type="checkbox"/>	Cable	H+B	CBL3-NN-12.5m	100319-21412500	May 16, 2015	1 Year

#### 3.3. For Harmonic Current / Flicker Measurement

Used	Equipment	Manufacturer	Model No.	Serial No.	Last Cal.	Cal. Interval
<input checked="" type="checkbox"/>	45KVA AC Power source	Teseq	NSG 1007-45/45K VA	1305A02873	May 16, 2015	1 Year
<input checked="" type="checkbox"/>	Signal conditioning Unit	Teseq	CCN 1000-3	1305A02873	May 16, 2015	1 Year
<input checked="" type="checkbox"/>	Three phase impedance network	Teseq/Germany	INA2197/37A	1305A02873	N/A	N/A
<input checked="" type="checkbox"/>	Three phase impedance network	Teseq/Germany	INA 2196/75A	1305A02874	N/A	N/A
<input type="checkbox"/>	Proflin 2100 AC Switching Unit	Teseq/Germany	NSG2200-3	A22714	N/A	N/A

#### 3.4. For Electrostatic Discharge Immunity Test

Used	Equipment	Manufacturer	Model No.	Serial No.	Last Cal.	Cal. Interval
<input checked="" type="checkbox"/>	ESD Tester	TESEQ AG	NSG 438A	130	May 16, 2015	1 Year
<input checked="" type="checkbox"/>	Impulse Module	TESEQ AG	INA 4380-150pF/330Ohm	403-550/1712	May 16, 2015	1 Year

### 3.5. For RF Strength Susceptibility Test

Used	Equipment	Manufacturer	Model No.	Serial No.	Last Cal.	Cal. Interval
<input checked="" type="checkbox"/>	Signal Generator	Agilent	N5181A	MY50145187	May 16, 2015	1 Year
<input checked="" type="checkbox"/>	RF Power Meter. Dual Channel	BOONTON	4232A	10539	May 16, 2015	1 Year
<input checked="" type="checkbox"/>	50ohm Diode Power Sensor	BOONTON	51011EMC	34236/34238	May 16, 2015	1 Year
<input checked="" type="checkbox"/>	Field Strength Meter	DARE	RSS1006A	10I00037SO 22	May 16, 2015	1 Year
<input checked="" type="checkbox"/>	50ohm Diode Power Sensor	BOONTON	51011EMC	36164	May 16, 2015	1 Year
<input checked="" type="checkbox"/>	Power Amplifier	MILMEGA	80RF1000-175	1059345	May 16, 2015	1 Year
<input type="checkbox"/>	Power Amplifier	MILMEGA	AS0102-55	1018770	May 16, 2015	1 Year
<input checked="" type="checkbox"/>	Power Amplifier	MILMEGA	AS1860-50	1059346	May 16, 2015	1 Year
<input checked="" type="checkbox"/>	Log.-Per. Antenna	SCHWARZBECK	VULP 9118E	N/A	May 16, 2015	1 Year
<input type="checkbox"/>	Broad-Band Horn Antenna	SCHWARZBECK	STLP 9149	9149-227	May 16, 2015	1 Year
<input checked="" type="checkbox"/>	Multi-function interface system	DARE	CTR1009B	12I00250SN O72	N/A	N/A
<input checked="" type="checkbox"/>	Automatic switch group	DARE	RSW1004A	N/A	N/A	N/A

### 3.6. For Electrical Fast Transient /Burst Immunity Test

Used	Equipment	Manufacturer	Model No.	Serial No.	Last Cal.	Cal. Interval
<input checked="" type="checkbox"/>	Burst Tester	HAEFELY	PEFT4010	080981-16	May 16, 2015	1Year
<input checked="" type="checkbox"/>	Coupling Clamp	HAEFELY	IP-4A	147147	May 16, 2015	1Year
<input type="checkbox"/>	Three phase CDN	Teseq	CDN 163	202	May 16, 2015	1 Year

### 3.7. For Surge Immunity Test

Used	Equipment	Manufacturer	Model No.	Serial No.	Last Cal.	Cal. Interval
<input checked="" type="checkbox"/>	Surge Controller	HAEFELY	Psurge 8000	174031	May 16, 2015	1Year
<input checked="" type="checkbox"/>	Impulse Module	HAEFELY	PIM 100	174124	May 16, 2015	1Year
<input checked="" type="checkbox"/>	Coupling Decoupling Filter	HAEFELY	PCD 130	172181	May 16, 2015	1Year

### 3.8. For Injected Current Susceptibility Test

Used	Equipment	Manufacturer	Model No.	Serial No.	Last Cal.	Cal. Interval
<input checked="" type="checkbox"/>	Simulator	EMTEST	CWS500C	0900-12	May 16, 2015	1Year
<input type="checkbox"/>	CDN	EMTEST	CDN-M2	5100100100	May 16, 2015	1Year
<input checked="" type="checkbox"/>	CDN	EMTEST	CDN-M3	0900-11	May 16, 2015	1Year
<input checked="" type="checkbox"/>	Injection Clamp	EMTEST	F-2031-23MM	368	May 16, 2015	1Year
<input checked="" type="checkbox"/>	Attenuator	EMTEST	ATT6	0010222A	May 16, 2015	1Year
<input type="checkbox"/>	Three phase CDN	Teseq	CDN M332S	32655	May 16, 2015	1 Year
<input type="checkbox"/>	Three phase CDN	Teseq	CDN M432S	33670	May 16, 2015	1 Year
<input type="checkbox"/>	Three phase CDN	Teseq	CDN M432-3LNS	34048	May 16, 2015	1 Year
<input type="checkbox"/>	Three phase CDN	Teseq	CDN M532S	33799	May 16, 2015	1 Year

### 3.9. For Magnetic Field Immunity Test

Used	Equipment	Manufacturer	Model No.	Serial No.	Last Cal.	Cal. Interval
<input checked="" type="checkbox"/>	Magnetic Field Tester	HAEFELY	MAG100	250040.1	May 16, 2015	1Year

### 3.10. Low Frequency Signals Test

Used	Equipment	Manufacturer	Model No.	Serial No.	Last Cal.	Cal. Interval
<input checked="" type="checkbox"/>	Programmable AC Source	CHROMA	6530	/	May 16, 2015	1Year

## 4. CONDUCTED EMISSION MEASUREMENT

### 4.1. Block Diagram of Test Setup

For AC Mains:

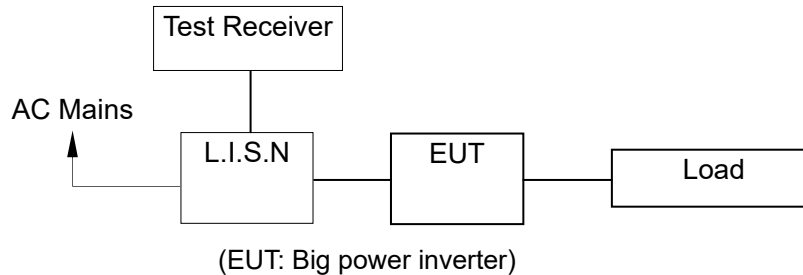

### 4.2. Measuring Standard

EN62040-2: 2006, IEC 62040-2:2005 Category C2  
Power Line Conducted Emission Limits

Frequency (MHz)	Limit (dB $\mu$ V)	
	Quasi-peak Level	Average Level
0.15 ~ 0.50	79	66
0.50 ~ 5.0	73	60
5.0 ~ 30.00	73	60

NOTE1- The lower limit shall apply at the transition frequencies.  
NOTE2- An allowance of +14 dB is permitted for conducted disturbances.

### 4.3. EUT Configuration on Measurement

The following equipments are installed on Conducted Emission Measurement to meet EN 62040-2 requirements and operating in a manner which tends to maximize its emission characteristics in a normal application.

Big power inverter (EUT)  
 Model Number : APS-2012SW-LCD  
 Serial Number : N/A

### 4.4. Operating Condition of EUT

- 4.4.1. Setup the EUT as shown on Section 4.1.
- 4.4.2. Turn on the power of all equipments.
- 4.4.3. Let the EUT work in measuring mode (Line mode, Battery mode) and measure it.

#### 4.5. Test Procedure

The EUT is put on the plane 0.8m high above the ground by insulating support and connected to the AC mains through Line Impedance Stability Network (L.I.S.N) or connected to the telecommunication port through an impedance stabilization network (ISN). L.I.S.N provided a 50ohm coupling impedance for the tested equipments AC mains port, I.S.N provided a common mode (asymmetric mode) impedance of 150  $\Omega$  to the telecommunication port under test. Both sides of AC line and telecommunication line are investigated to find out the maximum conducted emission according to the EN 62040-2 regulations during conducted emission measurement.

The bandwidth of the field strength meter (R&S Test Receiver ESCS30) is set at 9KHz in 150KHz~30MHz and 200Hz in 9KHz~150KHz.

The frequency range from 150kHz to 30MHz is investigated

#### 4.6. Measuring Results

**PASS.**

Please refer to the following pages.

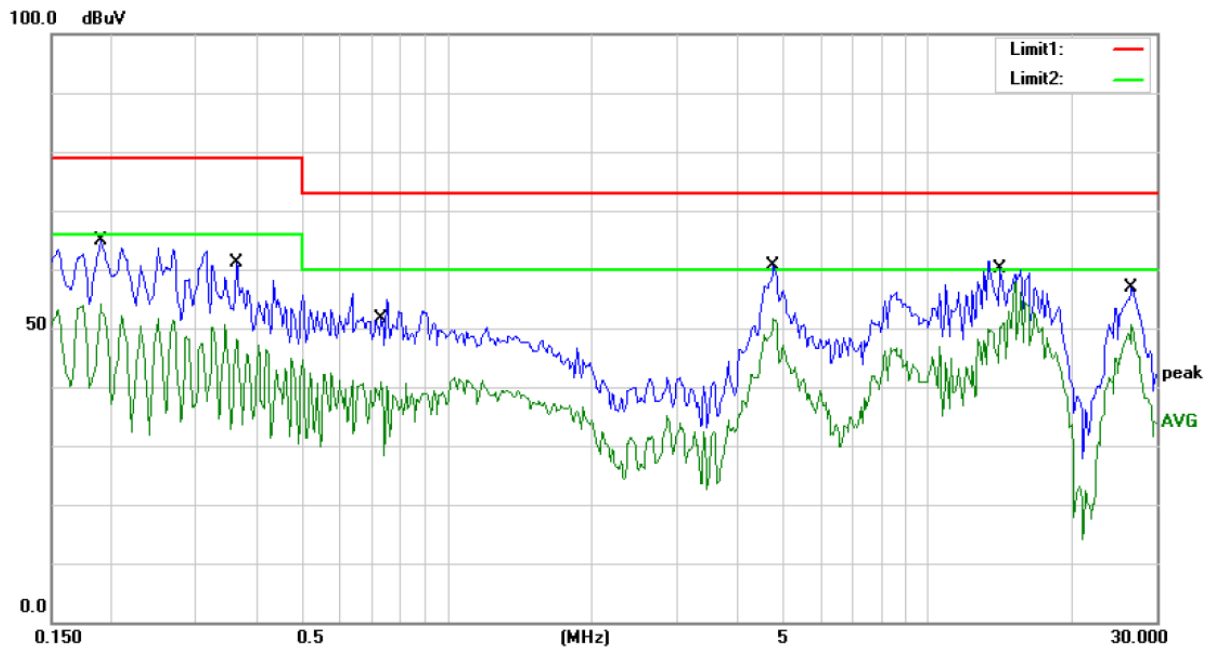

Site Conduction #2  
 Limit: (CE)EN62040-2 C2\_QP  
 Mode: LINE MODE  
 Note:

Phase: **L1**  
 Power: AC 230V/50Hz

Temperature: 26  
 Humidity: 55 %

No.	Mk.	Freq. MHz	Reading Level dBuV	Correct Factor dB	Measure- ment dBuV	Limit dBuV	Over dB	Detector	Comment
1		0.1900	54.12	0.00	54.12	66.00	-11.88	AVG	
2		0.1900	63.66	0.00	63.66	79.00	-15.34	QP	
3		0.3650	48.19	0.00	48.19	66.00	-17.81	AVG	
4		0.3650	58.19	0.00	58.19	79.00	-20.81	QP	
5		0.7300	40.94	0.00	40.94	60.00	-19.06	AVG	
6		0.7300	54.82	0.00	54.82	73.00	-18.18	QP	
7		4.7800	60.59	0.00	60.59	73.00	-12.41	QP	
8		4.7800	51.64	0.00	51.64	60.00	-8.36	AVG	
9		14.1500	60.16	0.00	60.16	73.00	-12.84	QP	
10	*	14.1500	57.77	0.00	57.77	60.00	-2.23	AVG	
11		26.6500	56.82	0.00	56.82	73.00	-16.18	QP	
12		26.6500	50.56	0.00	50.56	60.00	-9.44	AVG	

\*:Maximum data    x:Over limit    !:over margin    Comment: Factor build in receiver.    Operator:

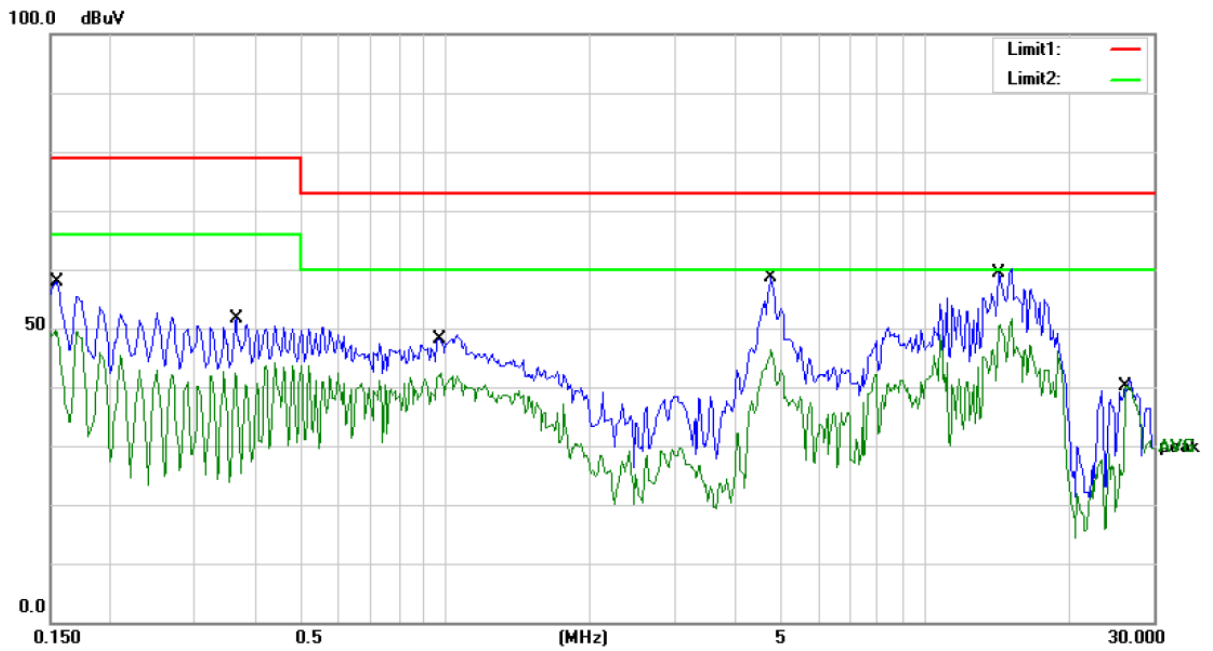

Site Conduction #2

Phase: **N**

Temperature: 26

Limit: (CE)EN62040-2 C2\_QP

Power: AC 230V/50Hz

Humidity: 55 %

Mode: LINE MODE

Note:

No.	Mk.	Freq. MHz	Reading Level dBuV	Correct Factor dB	Measure- ment dBuV	Limit dBuV	Over dB	Detector	Comment
1		0.1532	49.58	0.00	49.58	66.00	-16.42	AVG	
2		0.1532	55.37	0.00	55.37	79.00	-23.63	QP	
3		0.3653	51.58	0.00	51.58	79.00	-27.42	QP	
4		0.3653	43.34	0.00	43.34	66.00	-22.66	AVG	
5		0.9800	42.29	0.00	42.29	60.00	-17.71	AVG	
6		0.9800	48.93	0.00	48.93	73.00	-24.07	QP	
7		4.7800	58.55	0.00	58.55	73.00	-14.45	QP	
8		4.7800	46.47	0.00	46.47	60.00	-13.53	AVG	
9		14.2250	59.26	0.00	59.26	73.00	-13.74	QP	
10	*	14.2250	51.57	0.00	51.57	60.00	-8.43	AVG	
11		26.1500	40.22	0.00	40.22	60.00	-19.78	AVG	
12		26.1500	41.29	0.00	41.29	73.00	-31.71	QP	

\*:Maximum data    x:Over limit    !:over margin    Comment: Factor build in receiver.    Operator:



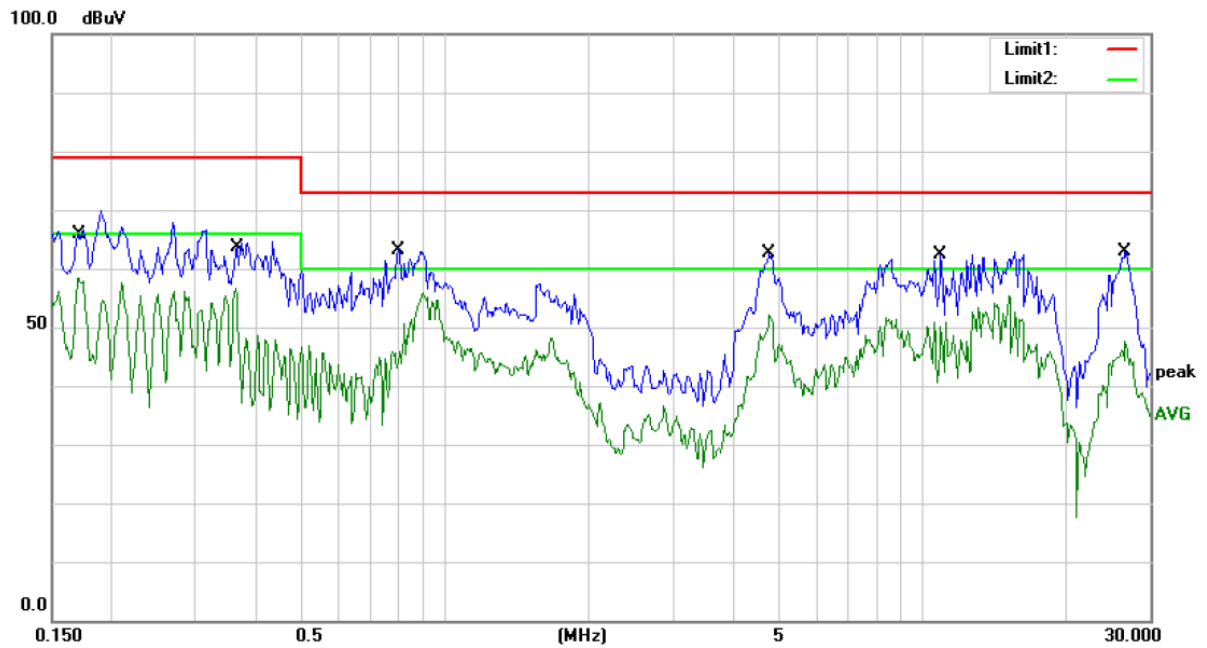

Site Conduction #2 Phase: **L1** Temperature: 26  
 Limit: (CE)EN62040-2 C2\_QP Power: DC 12V Humidity: 55 %  
 Mode: BAT MODE  
 Note:

No.	Mk.	Freq. MHz	Reading Level dBuV	Correct Factor dB	Measure- ment dBuV	Limit dBuV	Over dB	Detector	Comment
1		0.1703	58.39	0.00	58.39	66.00	-7.61	AVG	
2		0.1703	69.90	0.00	69.90	79.00	-9.10	QP	
3		0.3650	56.69	0.00	56.69	66.00	-9.31	AVG	
4		0.3650	64.69	0.00	64.69	79.00	-14.31	QP	
5		0.7960	63.23	0.00	63.23	73.00	-9.77	QP	
6	*	0.7960	54.14	0.00	54.14	60.00	-5.86	AVG	
7		4.7800	62.59	0.00	62.59	73.00	-10.41	QP	
8		4.7800	52.14	0.00	52.14	60.00	-7.86	AVG	
9		10.9250	62.49	0.00	62.49	73.00	-10.51	QP	
10		10.9250	52.51	0.00	52.51	60.00	-7.49	AVG	
11		26.6500	62.82	0.00	62.82	73.00	-10.18	QP	
12		26.6500	47.56	0.00	47.56	60.00	-12.44	AVG	

\*:Maximum data    x:Over limit    !:over margin    Comment: Factor build in receiver.    Operator:

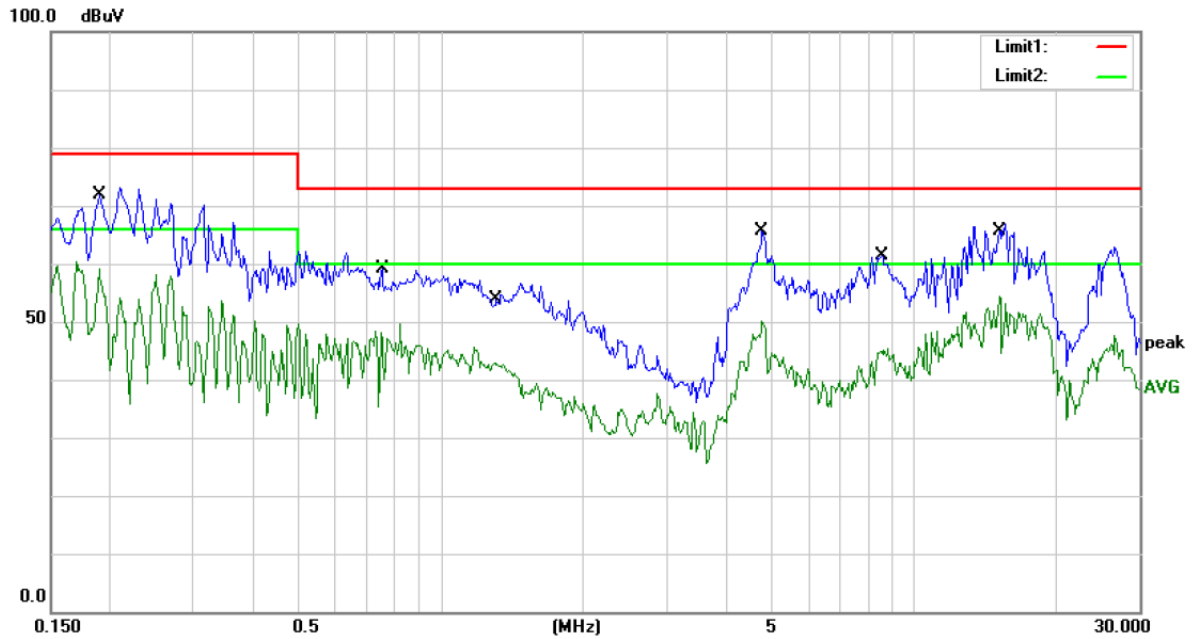

Site Conduction #2

Phase: **N**

Temperature: 26

Limit: (CE)EN62040-2 C2\_QP

Power: DC 12V

Humidity: 55 %

Mode: BAT MODE

Note:

No. Mk.	Freq. MHz	Reading Level dBuV	Correct Factor dB	Measure- ment dBuV	Limit dBuV	Over dB	Detector	Comment
1	0.1900	59.12	0.00	59.12	66.00	-6.88	AVG	
2	0.1900	73.16	0.00	73.16	79.00	-5.84	QP	
3	0.7510	59.21	0.00	59.21	73.00	-13.79	QP	
4	0.7510	49.61	0.00	49.61	60.00	-10.39	AVG	
5	1.3000	42.88	0.00	42.88	60.00	-17.12	AVG	
6	1.3000	56.42	0.00	56.42	73.00	-16.58	QP	
7	4.7800	65.59	0.00	65.59	73.00	-7.41	QP	
8	4.7800	50.14	0.00	50.14	60.00	-9.86	AVG	
9	8.5462	61.26	0.00	61.26	73.00	-11.74	QP	
10	8.5462	45.56	0.00	45.56	60.00	-14.44	AVG	
11 *	15.2250	54.27	0.00	54.27	60.00	-5.73	AVG	
12	15.2250	66.85	0.00	66.85	73.00	-6.15	QP	

\*:Maximum data    x:Over limit    !:over margin    Comment: Factor build in receiver.    Operator:

## 5. RADIATED EMISSION MEASUREMENT

### 5.1. Block Diagram of Test

#### 5.1.1. Block diagram of connection between the EUT and simulators

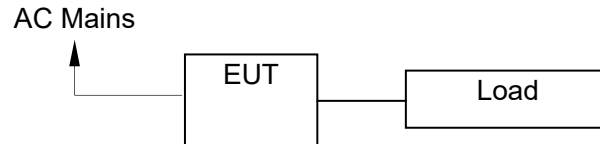

(EUT: Big power inverter)

#### 5.1.2. Block diagram of test setup (In chamber)

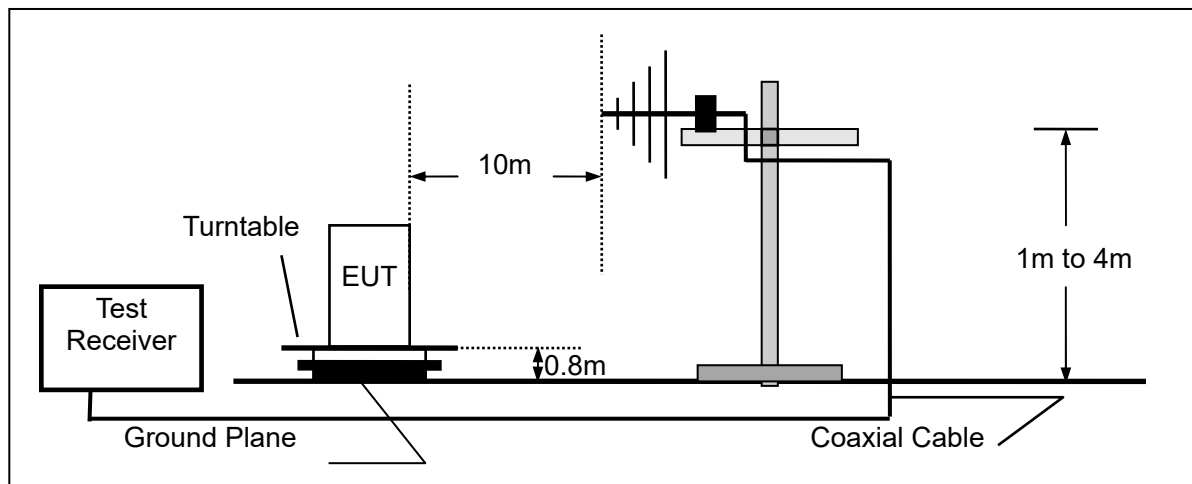

(EUT: Big power inverter)

### 5.2. Measuring Standard

EN62040-2: 2006 Category C2.

### 5.3. Radiated Emission Limits

All emanations from device or system, including any network of conductors and apparatus connected thereto, shall not exceed the level of field strengths specified below:

FREQUENCY (MHz)	DISTANCE (Meters)	FIELD STRENGTHS LIMIT (dB $\mu$ V/m)
30 ~ 230	10	40
230 ~ 1000	10	47

Note: (1) The smaller limit shall apply at the combination point between two frequency bands.  
(2) Distance refers to the distance in meters between the measuring instrument antenna and the closed point of any part of the EUT.

#### 5.4. EUT Configuration on Test

The EN 62040-2 regulations test method must be used to find the maximum emission during radiated emission measurement.

#### 5.5. Operating Condition of EUT

5.5.1. Turn on the power.

5.5.2. After that, let the EUT work in test mode (Line mode, Battery mode) and measure it.

#### 5.6. Test Procedure

The EUT is placed on a turn table which is 0.8m high above the ground. The turn table can rotate 360 degrees to determine the position of the maximum emission level. The EUT is set 10 meters away from the receiving antenna which is mounted on an antenna tower. The antenna can be moved up and down from 1 to 4 meters to find out the maximum emission level. Bilog antenna (calibrated by Dipole Antenna) is used as a receiving antenna. Both horizontal and vertical polarization of the antenna is set on test.

The bandwidth of the Receiver is set at 120 kHz.

#### 5.7. Measuring Results

**PASS.**

The frequency range from 30MHz to 1000MHz is investigated.

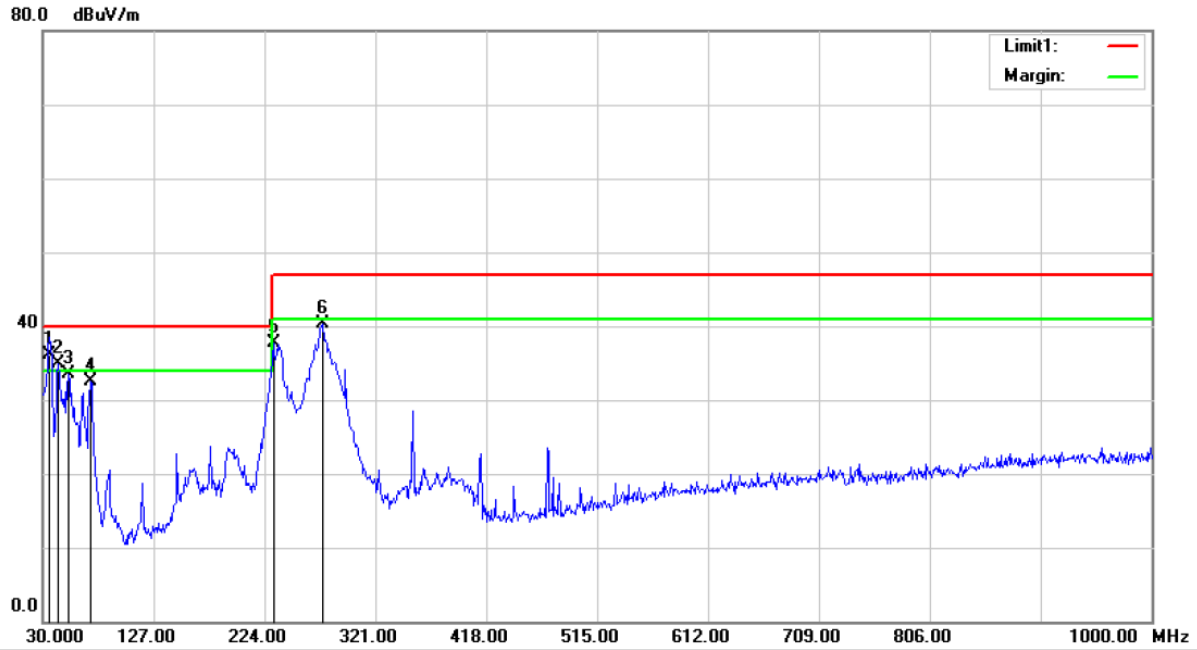

Site :10m Chamber #1

Polarization: *Horizontal*

Temperature: 26

Limit: (RE 10M)EN62040-2 C2

Power: AC 230V/50Hz

Humidity: 60 %

Mode:LINE MODE

Note:

No.	Mk.	Freq.	Reading Level	Correct Factor	Measurement	Limit	Over	Antenna Height	Table Degree	Comment
		MHz	dBuV	dB	dBuV/m	dBuV/m	dB	cm	degree	
1	*	35.8200	68.86	-32.76	36.10	40.00	-3.90	QP		
2	!	43.5800	65.69	-30.71	34.98	40.00	-5.02	QP		
3		52.3100	64.27	-30.75	33.52	40.00	-6.48	QP		
4		71.7100	67.42	-34.83	32.59	40.00	-7.41	QP		
5		231.7600	68.92	-31.16	37.76	47.00	-9.24	QP		
6		275.4100	70.32	-30.07	40.25	47.00	-6.75	QP		

\*:Maximum data    x:Over limit    !:over margin

Operator: CSL

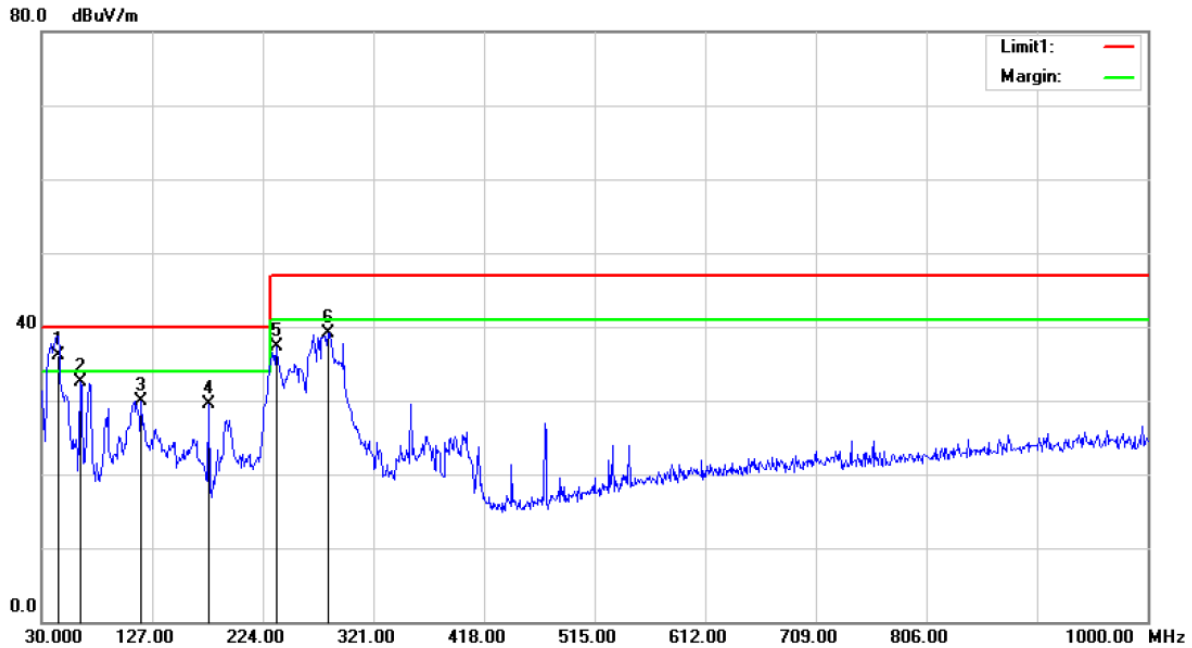

Site :10m Chamber #1      Polarization: **Vertical**      Temperature: 26  
 Limit: (RE 10M)EN62040-2 C2      Power: AC 230V/50Hz      Humidity: 60 %  
 Mode:LINE MODE  
 Note:

No.	Mk.	Freq. MHz	Reading Level dBuV	Correct Factor dB	Measure- ment dBuV/m	Limit dBuV/m	Over dB	Antenna Height cm	Table Degree	Comment
1	*	44.5500	66.27	-30.07	36.20	40.00	-3.80	QP		
2		63.9500	63.70	-31.18	32.52	40.00	-7.48	QP		
3		117.3000	62.77	-32.84	29.93	40.00	-10.07	QP		
4		176.4700	62.86	-33.32	29.54	40.00	-10.46	QP		
5		235.6400	67.36	-29.99	37.37	47.00	-9.63	QP		
6		281.2300	67.96	-28.77	39.19	47.00	-7.81	QP		

\*:Maximum data    x:Over limit    !:over margin

Operator: CSL

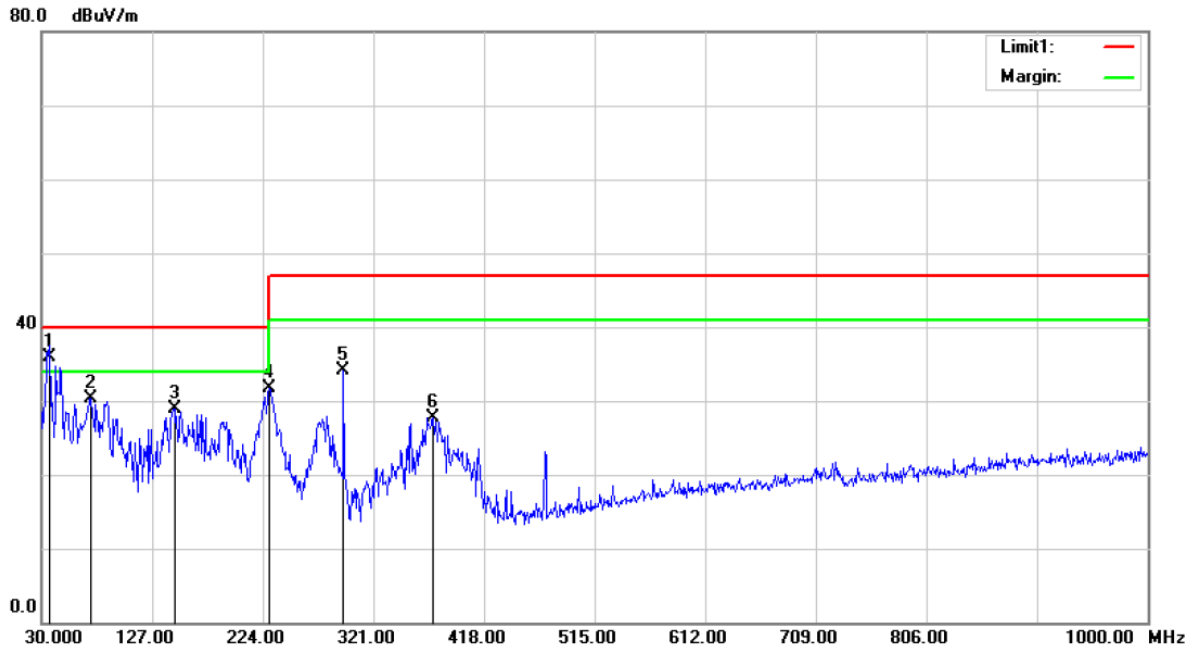

Site :10m Chamber #1      Polarization: **Horizontal**      Temperature: 26  
 Limit: (RE 10M)EN62040-2 C2      Power: DC 12V      Humidity: 60 %  
 Mode:BAT MODE  
 Note:

No.	Mk.	Freq. MHz	Reading Level dBuV	Correct Factor dB	Measure- ment dBuV/m	Limit dBuV/m	Over dB	Antenna Height cm	Table Degree degree	Comment
1	*	36.7900	68.44	-32.44	36.00	40.00	-4.00	QP		
2		73.6500	65.50	-35.20	30.30	40.00	-9.70	QP		
3		146.4000	64.58	-35.72	28.86	40.00	-11.14	QP		
4		229.8200	62.92	-31.21	31.71	40.00	-8.29	QP		
5		294.8100	63.69	-29.62	34.07	47.00	-12.93	QP		
6		373.3800	55.58	-27.79	27.79	47.00	-19.21	QP		

\*:Maximum data    x:Over limit    !:over margin

Operator: CSL





## 6. HARMONIC CURRENT EMISSION MEASUREMENT

### 6.1. Block Diagram of Test Setup

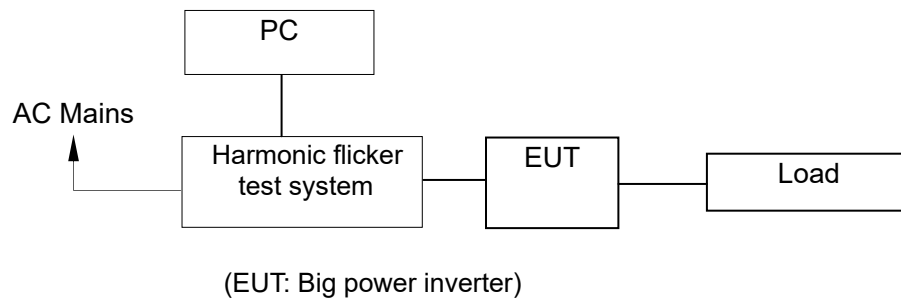

### 6.2. Measuring Standard

EN 61000-3-2: 2014 CLASS A

### 6.3. Operation Condition of EUT

6.3.1. Setup the EUT as shown on Section 6.1.

6.3.2. Turn on the power of all equipments.

6.3.3. Let the EUT work in measuring mode (Line Mode) and measure it.

### 6.4. Measuring Results

**PASS.**

Please refer to the following pages.

**Harmonics – Class-A per Ed. 4.0 (2014)(Run time) incl. inter-harmonics**

EUT: ups  
 Test category: Class-A per Ed. 4.0 (2014) (European limits)  
 Test date: 2015/6/23  
 Test duration (min): 2.5  
 Comment: Line Mode  
 Customer: SUMRY

Tested by: tzh  
 Test Margin: 100  
 Start time: 18:52:12  
 End time: 18:55:04  
 Data file name: WIN2105\_H-000454.cts\_data

Test Result: Pass                      Source qualification: Normal

Current & voltage waveforms

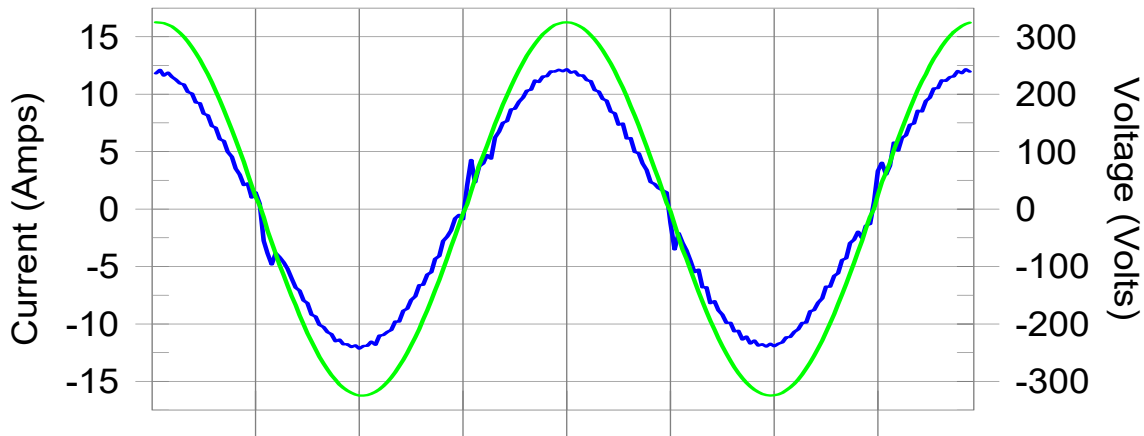

Harmonics and Class A limit line                      European Limits

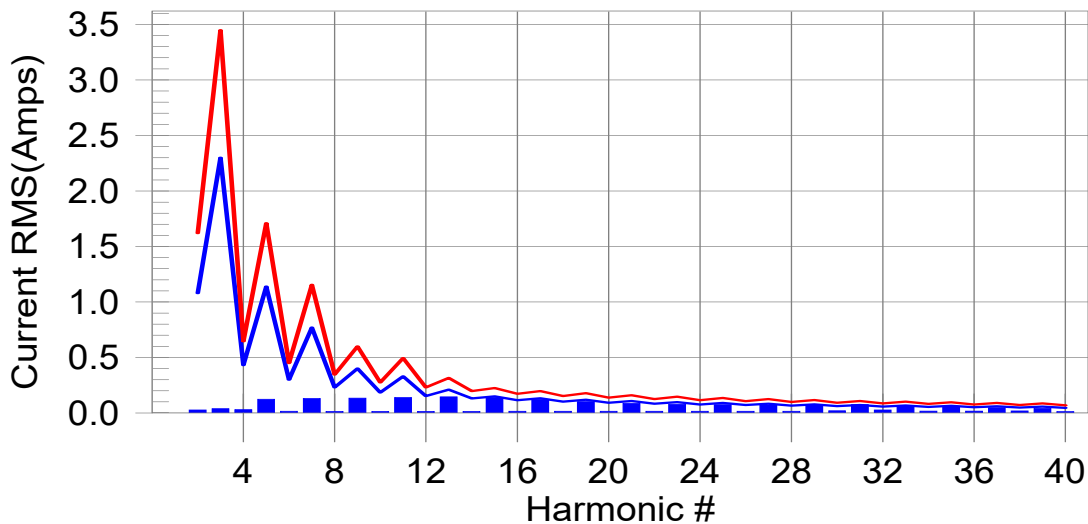

Test result: Pass                      Worst harmonic was #31 with 99.7% of the limit.

**Current Test Result Summary (Run time)**

EUT:UPS  
 Test category: Class-A per Ed. 4.0 (2014) (European limits)  
 Test date: 2015/6/23  
 Test duration (min): 2.5  
 Comment: Line Mode  
 Customer: SUMRY

Tested by: TZH  
 Test Margin: 100  
 Start time: 18:52:12  
 End time: 18:55:04  
 Data file name: WIN2105\_H-000454.cts\_data

Test Result: Pass  
 Source qualification: Normal  
 THC: 0.436 A I-THD: 5.2 % POHC(A): 0.217 A POHC Limit(A): 0.251 A

Highest parameter values during test:

V_RMS (Volts): 229.944	Frequency(Hz): 50.00
I_Peak (Amps): 12.585	I_RMS (Amps): 8.463
I_Fund (Amps): 8.448	Crest Factor: 1.487
Power (Watts): 1938.3	Power Factor: 0.996

Harm#	Harms(avg)	100%Limit	%of Limit	Harms(max)	150%Limit	%of Limit	Status
2	0.026	1.080	2.4	0.032	1.620	2.0	Pass
3	0.038	2.300	1.7	0.044	3.450	1.3	Pass
4	0.030	0.430	7.1	0.033	0.645	5.1	Pass
5	0.124	1.140	10.8	0.126	1.710	7.3	Pass
6	0.015	0.300	5.0	0.017	0.450	3.9	Pass
7	0.130	0.770	16.9	0.132	1.155	11.5	Pass
8	0.014	0.230	5.9	0.016	0.345	4.6	Pass
9	0.133	0.400	33.3	0.139	0.600	23.1	Pass
10	0.014	0.184	7.7	0.017	0.276	6.1	Pass
11	0.140	0.330	42.3	0.144	0.495	29.2	Pass
12	0.014	0.153	9.2	0.017	0.230	7.3	Pass
13	0.146	0.210	69.3	0.150	0.315	47.7	Pass
14	0.014	0.131	10.8	0.016	0.197	8.3	Pass
15	0.139	0.150	93.0	0.145	0.225	64.4	Pass
16	0.015	0.115	13.0	0.017	0.173	9.9	Pass
17	0.122	0.132	92.3	0.128	0.198	64.7	Pass
18	0.015	0.102	14.3	0.020	0.153	12.8	Pass
19	0.103	0.118	86.7	0.108	0.178	60.6	Pass
20	0.015	0.092	15.8	0.020	0.138	14.2	Pass
21	0.088	0.107	82.1	0.093	0.161	57.8	Pass
22	0.015	0.084	17.7	0.017	0.125	13.4	Pass
23	0.078	0.098	80.0	0.081	0.147	55.2	Pass
24	0.015	0.077	19.8	0.018	0.115	15.2	Pass
25	0.074	0.090	82.0	0.076	0.135	56.1	Pass
26	0.016	0.071	22.5	0.019	0.107	17.6	Pass
27	0.072	0.083	86.3	0.074	0.125	59.5	Pass
28	0.016	0.066	24.4	0.018	0.099	18.4	Pass
29	0.073	0.078	93.8	0.076	0.116	64.9	Pass
30	0.019	0.061	31.2	0.036	0.092	39.1	Pass
31	0.073	0.073	99.7	0.085	0.109	77.7	Pass
32	0.027	0.058	46.7	0.039	0.086	45.7	Pass
33	0.067	0.068	98.5	0.077	0.102	75.6	Pass
34	0.017	0.054	31.4	0.020	0.081	24.1	Pass
35	0.056	0.064	87.7	0.059	0.096	61.5	Pass
36	0.017	0.051	33.7	0.020	0.077	25.9	Pass
37	0.047	0.061	77.1	0.050	0.091	54.6	Pass
38	0.018	0.048	37.5	0.022	0.073	29.7	Pass
39	0.041	0.058	71.6	0.045	0.087	52.2	Pass
40	0.013	0.046	29.1	0.016	0.069	23.1	Pass

### Voltage Source Verification Data (Run time)

EUT: UPS Tested by: TZH  
 Test category: Class-A per Ed. 4.0 (2014) (European limits) Test Margin: 100  
 Test date: 2015/6/23 Start time: 18:52:12 End time: 18:55:04  
 Test duration (min): 2.5 Data file name: WIN2105\_H-000454.cts\_data  
 Comment: Line Mode  
 Customer: SUMRY

Test Result: Pass Source qualification: Normal

Highest parameter values during test:

Voltage (Vrms): 229.944	Frequency(Hz): 50.00
I_Peak (Amps): 12.585	I_RMS (Amps): 8.463
I_Fund (Amps): 8.448	Crest Factor: 1.487
Power (Watts): 1938.3	Power Factor: 0.996

Harm#	Harmonics V-rms	Limit V-rms	% of Limit	Status
2	0.093	0.460	20.26	OK
3	0.176	2.069	8.52	OK
4	0.040	0.460	8.70	OK
5	0.120	0.920	13.03	OK
6	0.020	0.460	4.31	OK
7	0.173	0.690	25.12	OK
8	0.020	0.460	4.27	OK
9	0.183	0.460	39.83	OK
10	0.022	0.460	4.83	OK
11	0.204	0.230	88.56	OK
12	0.020	0.230	8.56	OK
13	0.217	0.230	94.34	OK
14	0.019	0.230	8.15	OK
15	0.224	0.230	97.45	OK
16	0.022	0.230	9.56	OK
17	0.210	0.230	91.43	OK
18	0.023	0.230	9.81	OK
19	0.199	0.230	86.53	OK
20	0.021	0.230	9.32	OK
21	0.189	0.230	82.14	OK
22	0.021	0.230	9.02	OK
23	0.176	0.230	76.75	OK
24	0.021	0.230	9.32	OK
25	0.173	0.230	75.37	OK
26	0.030	0.230	12.84	OK
27	0.165	0.230	71.79	OK
28	0.024	0.230	10.27	OK
29	0.168	0.230	73.02	OK
30	0.022	0.230	9.54	OK
31	0.199	0.230	86.69	OK
32	0.048	0.230	20.67	OK
33	0.184	0.230	80.16	OK
34	0.024	0.230	10.26	OK
35	0.166	0.230	72.03	OK
36	0.022	0.230	9.43	OK
37	0.146	0.230	63.68	OK
38	0.030	0.230	12.98	OK
39	0.145	0.230	63.23	OK
40	0.030	0.230	13.20	OK

## 7. VOLTAGE FLUCTUATION AND FLICKER MEASUREMENT

### 7.1. Block Diagram of Test Setup

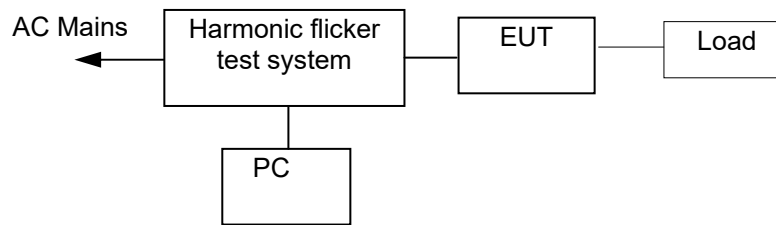

(EUT: LED Driver)

### 7.2. Measuring Standard

EN 61000-3-3:2013

### 7.3. Operation Condition of EUT

7.3.1. Setup the EUT as shown on Section 7.1.

7.3.2. Turn on the power of all equipments.

7.3.3. Let the EUT work in measuring mode (Line Mode) and measure it.

### 7.4. Measuring Results

**PASS.**

Please see the attached page.



## 8. IMMUNITY PERFORMANCE CRITERIA DESCRIPTION

### Performance Level

The test results shall be classified in terms of the loss of function or degradation of performance of the equipment under test, relative to a performance level by its manufacturer or the requestor of the test, or the agreed between the manufacturer and the purchaser of the product.

Definition related to the performance level:

1. Based on the used product standard
2. Based on the declaration of the manufacturer, requestor or purchaser

Criterion A:

Definition: normal performance within limits specified by the manufacturer, requestor and purchaser.

The equipment shall continue to operate as intended without operator intervention. No degradation of performance or loss of function is allowed below a performance level specified by the manufacturer when the equipment is used as intended. The performance level may be replaced by a permissible loss of performance. If the minimum performance level or the permissible performance loss is not specified by the manufacturer, then either of these may be derived from the product description and documentation, and by what the user may reasonably expect from the equipment if used as intended.

Criterion B:

Definition: temporary loss of function or degradation of performance which ceases after the disturbance ceases, and from which the equipment under test recovers its normal performance, without operator intervention.

After the test, the EUT shall continue to operate as intended without operator intervention. No degradation of performance or loss of function is allowed, after the application of the phenomena below a performance level specified by the manufacturer, when the EUT is used as intended. The performance level may be replaced by a permissible loss of performance. During the test, degradation of performance is allowed. However, no change of operating state or stored data is allowed to persist after the test. If the minimum performance level (or the permissible performance loss) is not specified by the manufacturer, then either of these may be derived from the product description and documentation, and by what the user may reasonably expect from the EUT if used as intended.

Criterion C:

Definition: temporary loss of function or degradation of performance, the correction of which requires operator intervention.

Loss of function is allowed, provided the function is self-recoverable, or can be restored by the operation of the controls by the user in accordance with the manufacturer's instructions. Functions, and/or information stored in non-volatile memory, or protected by a battery backup, shall not be lost.

## Criterion D

Definition: loss of function or degradation of performance, which is not recoverable, owing to damage to hardware or software, or loss of data.



## 9. ELECTROSTATIC DISCHARGE IMMUNITY TEST

### 9.1. Block Diagram of Test Setup

#### 9.1.1. Block diagram of connection between the EUT and simulators

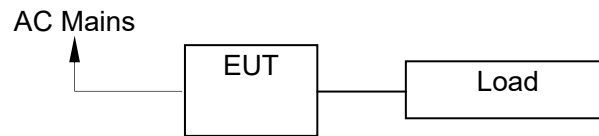

(EUT: Big power inverter)

#### 9.1.2. Block diagram of ESD test setup

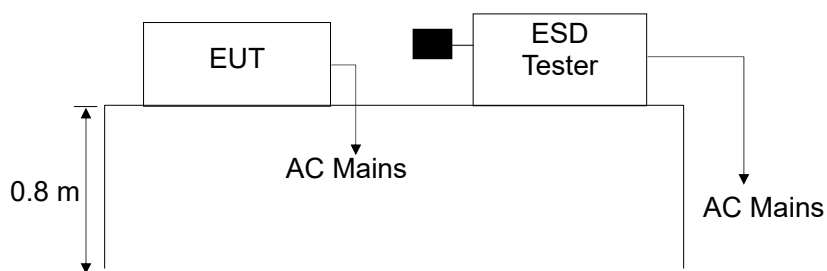

(EUT: Big power inverter)

### 9.2. Test Standard

IEC 61000-4-2:2008 (Air Discharge:  $\pm 8\text{KV}$ , Contact Discharge:  $\pm 4\text{KV}$ )

### 9.3. Severity Levels and Performance Criterion

#### 9.3.1. Severity level

Level	Test Voltage Contact Discharge (KV)	Test Voltage Air Discharge (KV)
1.	$\pm 2$	$\pm 2$
2.	$\pm 4$	$\pm 4$
3.	$\pm 6$	$\pm 8$
4.	$\pm 8$	$\pm 15$
X	Special	Special

#### 9.3.2. Performance criterion: B

	Criterion B
Output characteristics	Voltage permitted to vary within the inverse time characteristics applicable (<100 m sec limits in Figures 1, 2 or 3 of IEC 62040-3)
External and internal indications and metering	Change only during test
Control signals to external devices	Change only temporarily in consistency with the actual Uninterruptible Power Systems mode of operation
Mode of operation	Change only temporarily

## 9.4. EUT Configuration

The configuration of EUT is listed in Section 4.3.

## 9.5. Operating Condition of EUT

Same as the conducted emission measurement, which is listed in Section 4.4, and excepted the test set up replaced by Section 9.1.

## 9.6. Test Procedure

### 9.6.1. Air Discharge:

This test is done on a non-conductive surface. The round discharge tip of the discharge electrode shall be approached as fast as possible to touch the EUT. After each discharge, the discharge electrode shall be removed from the EUT. The generator is then re-triggered for a new single discharge and repeated 10 times for each pre-selected test point. This procedure shall be repeated until all the air discharge completed

### 9.6.2. Contact Discharge:

All the procedure shall be same as Section 9.6.1., and except that the tip of the discharge electrode shall touch the EUT before the discharge switch is operated.

### 9.6.3. Indirect discharge for horizontal coupling plane

At least 10 single discharging (in the most sensitive polarity) shall be applied at the front edge of each HCP opposite the center point of each unit (if applicable) of the EUT and 0.1m from the front of the EUT. The long axis of the discharge electrode shall be in the plane of the HCP and perpendicular to its front edge during the discharge.

### 9.6.4. Indirect discharge for vertical coupling plane

At least 10 single discharging (in the most sensitive polarity) shall be applied to the center of one vertical edge of the coupling plane. The coupling plane, of dimensions 0.5m X 0.5m, is placed parallel to, and positioned at a distance of 0.1m from the EUT. Discharges shall be applied to the coupling plane, with this plane in sufficient different positions that the four faces of the EUT are completely illuminated.

## 9.7. Test Results

**PASS**

Please refer to the following page.

## Electrostatic Discharge Test Result

SHENZHEN EMTEK CO., LTD

Applicant : MAGNIZON POWER SYSTEMS FZE	Test Date : June 13, 2015	
EUT : Big power inverter	Temperature : 22°C	
M/N : APS-2012SW-LCD	Humidity : 50%	
Power Supply : AC 230/50Hz	Actual Criterion : A	
Test Mode : Line mode	Air discharge : ±8KV	
Test Engineer : TZH	Contact discharge: ±4KV	
<b>Location</b>	<b>Kind</b> A-Air Discharge C-Contact Discharge	<b>Result</b>
Metal	C	A
Slot	A	A
Port	A	A
HCP	C	A
VCP of front	C	A
VCP of rear	C	A
VCP of left	C	A
VCP of right	C	A
Test Equipment: ESD Simulator (TESEQAG, NSG 437)		

## 10. RF FIELD STRENGTH SUSCEPTIBILITY TEST

### 10.1. Block Diagram of Test

#### 10.1.1. Block diagram of connection between the EUT and Load

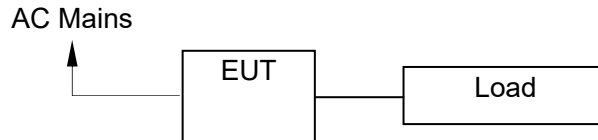

(EUT: Big power inverter)

#### 10.1.2. Block diagram of RS test setup

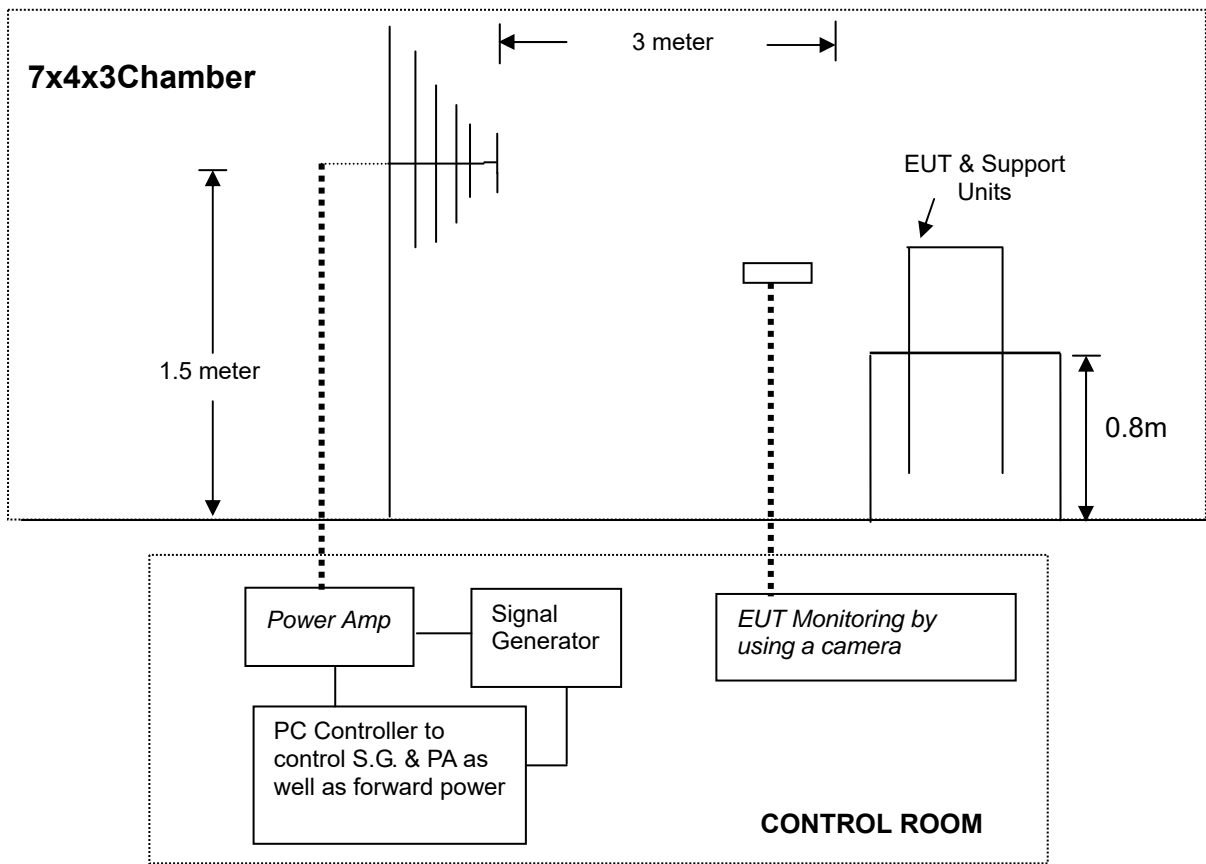

(EUT: Big power inverter)

### 10.2. Test Standard

IEC 61000-4-3:2006+A1:2007+A2:2010 (level 3: 10V / m)

### 10.3. Severity Levels and Performance Criterion

#### 10.3.1. Severity Levels

Level	Field Strength V/m
1.	1
2.	3
3.	10
4.	30
X	Special
NOTE x is an open test level and the associated field strength may be any value. This level may be given in the product standard.	

#### 10.3.2. Performance Criterion: A

	<b>Criterion A</b>
External and internal indications and metering (LCD)	No change
Output characteristics (Load)	No change
Control signals to external devices (Signal line)	No change
Mode of operation	No change

### 10.4. EUT Configuration on Test

The configuration of the EUT is same as Section 4.3.

### 10.5. Operating Condition of EUT

Same as radiated emission measurement which is listed in Section 4.4, except the test setup replaced as Section 10.1.

### 10.6. Test Procedure

The EUT and External Battery are placed on a table which is 0.8m high above the ground. The EUT is set 3 meters away from the transmitting antenna which is mounted on an antenna tower. Both horizontal and vertical polarization of the antenna is set on test. Each of the four sides of the EUT must be faced this transmitting antenna and measured individually.

In order to judge the EUT performance, a CCD camera is used to monitor its screen. All the scanning conditions are as following:

Condition of Test	Remark
-----	-----
1. Fielded Strength	10V/m
2. Radiated Signal	Modulated
3. Scanning Frequency	80-1000MHz
4. Sweep time of radiated	0.0015 Decade/s
5. Dwell Time	1 Sec.

## 10.7. Test Results

**PASS.**

Please refer to the following page.



## 11. ELECTRICAL FAST TRANSIENT/BURST IMMUNITY TEST

### 11.1. Block Diagram of Test Setup

#### 11.1.1. Block Diagram of the EUT

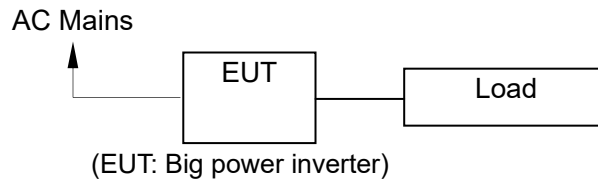

#### 11.1.2. EFT Test Setup

AC Port:

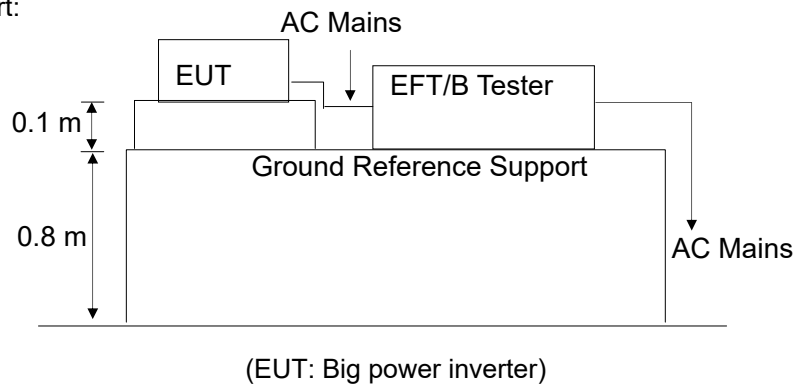

### 11.2. Test Standard

IEC61000-4-4:2012 (Level 3: 2KV/5kHz for AC Mains)

### 11.3. Severity Levels and Performance Criterion

#### 11.3.1. Severity level

Open Circuit Output Test Voltage $\pm 10\%$		
Level	On Power Supply Lines	On I/O (Input / Output) Signal data and control lines
1.	0.5 KV	0.25 KV
2.	1 KV	0.5 KV
3.	2 KV	1 KV
4.	4 KV	2 KV
X	Special	Special

#### 11.3.2. Performance criterion: B

Criterion B	
Output characteristics	Voltage permitted to vary within the inverse time characteristics applicable ( $< 100$ m sec limits in Figures 1, 2 or 3 of IEC 62040-3)
External and internal indications and metering	Change only during test
Control signals to external devices	Change only temporarily in consistency with the actual Uninterruptible Power Systems mode of operation
Mode of operation	Change only temporarily



#### 11.4.EUT Configuration

The configuration of EUT is listed in Section 4.4.

#### 11.5.Operating Condition of EUT

11.5.1.Setup the EUT as shown in Section 11.1.

11.5.2.Turn on the power of all equipments.

11.5.3.Let the EUT work in test mode (Line mode) and measure it.

#### 11.6.Test Procedure

The EUT and External Battery are put on the table which is 0.8m high above the ground. This reference ground plane shall project beyond the EUT by at least 0.1m on all sides and the minimum distance between EUT and all other conductive structure, except the ground plane beneath the EUT, shall be more than 0.5m.

11.6.1. For input and output AC power ports:

The EUT is connected to the power mains by using a coupling device which couples the EFT interference signal to AC power lines. Both polarities of the test voltage should be applied during compliance test and the duration of the test is 2 mins.

11.6.2. For signal line and control lines ports:

No I/O ports. It's unnecessary to test.

11.6.3. For DC output line ports:

No DC output port .It's unnecessary to test.

#### 11.7.Test Result

**PASS.**

Please refer to the following page.

## Electrical Fast Transient/Burst Test Results

EMTEK (SHENZHEN) CO., LTD.

Standard	IEC 61000-4-4	Result: <input checked="" type="checkbox"/> PASS / <input type="checkbox"/> FAIL	
Applicant : <u>MAGNIZON POWER SYSTEMS FZE</u>			
EUT : <u>Big power inverter</u>			
M/N : <u>APS-2012SW-LCD</u>			
Input Voltage: <u>AC 230/50Hz</u>			
Actual Criterion : B			
Ambient Condition :		<u>23 °C</u>	<u>52% RH</u>
Operation Mode: Line mode			
Line : <input checked="" type="checkbox"/> AC input and output power ports		Line : <input type="checkbox"/> Signal <input type="checkbox"/> DC line	
Coupling : <input checked="" type="checkbox"/> Direct		Coupling : <input type="checkbox"/> Capacitive	
Test Time : 120s			
Line	Test Voltage	Result(+)	Result(-)
L	2kV	A	A
N	2kV	A	A
PE	2kV	A	A
L、N	2kV	A	A
L、PE	2kV	A	A
N、PE	2kV	A	A
L、N、PE	2kV	A	A
Signal Line			
DC Line			
Note: /			
Test Equipment		Burst Tester Model : PEFT 4010, CDN 163	

## 12. SURGE IMMUNITY TEST

### 12.1. Block Diagram of Test Setup

#### 12.1.1. Block Diagram of the EUT

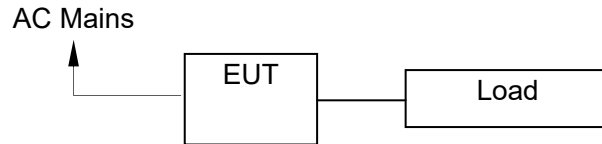

(EUT: Big power inverter)

#### 12.1.2. Surge Test Setup

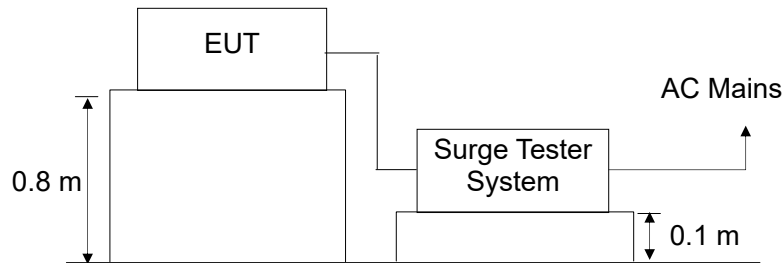

(EUT: Big power inverter)

### 12.2. Test Standard

IEC 61000-4-5:2005 (Line to Line: Level 2, 1.0KV, Line to earth: Level 3, 2.0KV)

### 12.3. Severity Levels and Performance Criterion

#### 12.3.1. Severity level

Severity Level	Open-Circuit Test Voltage KV
1	0.5
2	1.0
3	2.0
4	4.0
*	Special

#### 12.3.2. Performance criterion: B

	Criterion B
Output characteristics	Voltage permitted to vary within the inverse time characteristics applicable (<100 m sec limits in Figures 1, 2 or 3 of IEC 62040-3)
External and internal indications and metering	Change only during test
Control signals to external devices	Change only temporarily in consistency with the actual Uninterruptible Power Systems mode of operation
Mode of operation	Change only temporarily

## 12.4.EUT Configuration

The configuration of EUT is listed in Section 4.3.

## 12.5.Operating Condition of EUT

12.5.1.Setup the EUT as shown in Section 12.1.

12.5.2.Turn on the power of all equipments.

12.5.3.Let the EUT work in test mode (Line mode) and measure it.

## 12.6.Test Procedure

- 1) Set up the EUT and test generator as shown on Section 12.1.2.
- 2) For line to line coupling mode, provide 1.0KV 1.2/50us voltage surge, for line to earth mode, provide 2.0KV 1.2/50us voltage surge (at open-circuit condition) and 8/20us current surge to EUT selected points.
- 3) At least 5 positive and 5 negative (polarity) tests with a maximum 1/min repetition rate are conducted during test.
- 4) Different phase angles are done individually.
- 5) Record the EUT operating situation during compliance test and decide the EUT immunity criterion for above each test.

## 12.7.Test Result

**PASS.**

Please refer to the following page.



## 13. INJECTED CURRENTS SUSCEPTIBILITY TEST

### 13.1. Block Diagram of Test Setup

#### 13.1.1. Block Diagram of the EUT

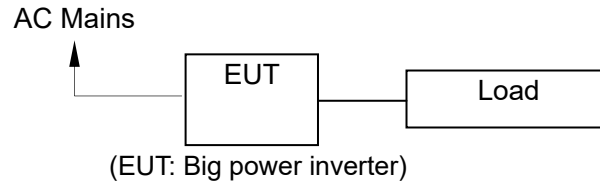

#### 13.1.2. Block Diagram of Test Setup

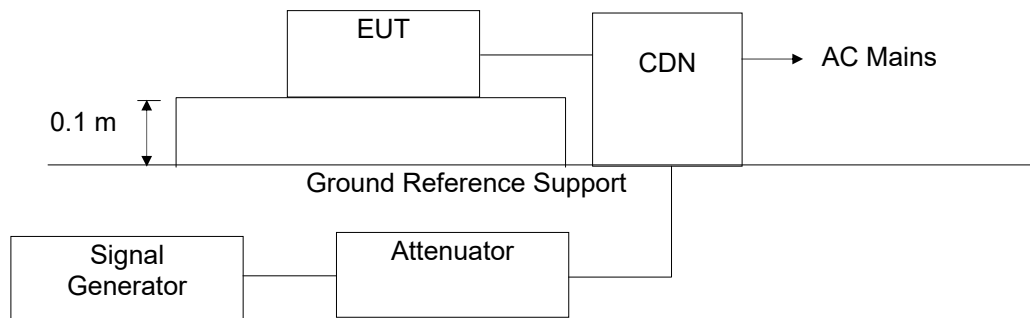

### 13.2. Test Standard

IEC 61000-4-6:2008 (Level 2: 3V (rms), (0.15MHz ~ 80MHz))

### 13.3. Severity Levels and Performance Criterion

#### 13.3.1. Severity level

Level	Field Strength V
1	1
2	3
3	10
X	Special

#### 13.3.2. Performance criterion: A

	Criterion A
External and internal indications and metering (LCD)	No change
Output characteristics (Load)	No change
Control signals to external devices (Signal line)	No change
Mode of operation	No change

### 13.4.EUT Configuration

The configuration of EUT is listed in Section 4.3.

### 13.5.Operating Condition of EUT

13.5.1.Setup the EUT as shown in Section 13.1.

13.5.2.Turn on the power of all equipments.

13.5.3.Let the EUT work in test mode (Line mode) and measure it.

### 13.6.Test Procedure

- 1) Set up the EUT, CDN and test generators as shown on Section 13.1.2.
- 2) Let the EUT work in test mode and measure it. The EUT are placed on an insulating support 0.1m high above a ground reference plane. CDN (coupling and decoupling device) is placed on the ground plane about 0.3m from EUT. Cables between CDN and EUT are as short as possible, and their height above the ground reference plane shall be between 30 and 50 mm (where possible).
- 3) The disturbance signal described below is injected to EUT through CDN.
- 4) The EUT operates within its operational mode(s) under intended climatic conditions after power on.
- 5) The frequency range is swept from 150 KHz to 80MHz using 10V signal level, and with the disturbance signal 80% amplitude modulated with a 1 KHz sine wave.
- 6) The rate of sweep shall not exceed  $1.5 \cdot 10^{-3}$  decades/s. Where the frequency is swept incrementally, the step size shall not exceed 1% of the start and thereafter 1% of the preceding frequency value.
- 7) Recording the EUT operating situation during compliance testing and decide the EUT immunity criterion.

### 13.7.Test Results

**PASS.**

Please refer to the following page.

## Injected Currents Susceptibility Test Results

EMTEK (SHENZHEN) CO., LTD.

Applicant : <u>MAGNIZON POWER SYSTEMS FZE</u> EUT : <u>Big power inverter</u> M/N : <u>APS-2012SW-LCD</u> Power Supply : <u>AC 230/50Hz</u> Test Engineer : <u>TZH</u>			Test Date: <u>June 13, 2015</u> Temperature : <u>23°C</u> Humidity : <u>50%</u> Actual Criterion : <u>A</u>	
Test Mode : <u>Line mode</u>				
Frequency Range (MHz)	Injected Position	Strength (Unmodulated)	Criterion	Result
0.15 ~ 80	AC Input	3V	A	A
0.15 ~ 80	AC Output	3V	A	A
Remark : 1. Modulation Signal:1kHz 80% AM Measurement Equipment : Simulator: CWS 500 (SWITZERLAND EMTEST) CDN : <input type="checkbox"/> CDN-M2 (SWITZERLAND EMTEST) <input checked="" type="checkbox"/> CDN-M3 (SWITZERLAND EMTEST)			Note: /	



## 14. MAGNETIC FIELD SUSCEPTIBILITY TEST

### 14.1. Block Diagram of Test

#### 14.1.1. Block diagram of test setup

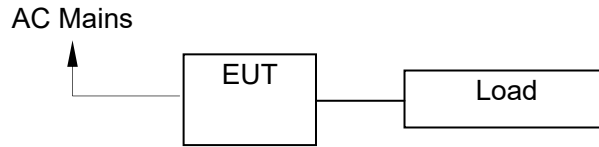

(EUT: Big power inverter)

#### 14.1.2. Magnetic field test setup

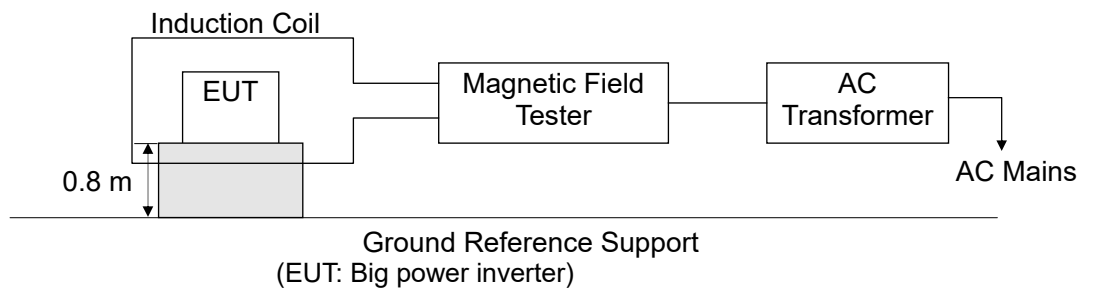

(EUT: Big power inverter)

### 14.2. Test Standard

IEC 61000-4-8:2009, (Severity Level 3: 10A / m)

### 14.3. Severity Levels and Performance Criterion

#### 14.3.1. Severity Levels

Level	Field Strength A/m
1	1
2	3
3	10
4	30
5	100
X	Special

#### 14.3.2. Performance Criterion: A

	Criterion A
Output characteristics	Voltage permitted to vary within the inverse time characteristics applicable (<100 m sec limits in Figures 1, 2 or 3 of IEC 62040-3)
External and internal indications and metering	Change only during test
Control signals to external devices	Change only temporarily in consistency with the actual Uninterruptible Power Systems mode of operation
Mode of operation	Change only temporarily

#### 14.4.EUT Configuration on Test

The configuration of the EUT is same as Section 4.3.

#### 14.5.Test Procedure

The EUT and External Battery are placed in the middle of a induction coil (1\*1m), under which is a 1\*1\*0.1m (high) table, this small table is also placed on a larger table, 0.8 m above the ground. Both horizontal and vertical polarization of the induction coil is set on test, so that each side of the EUT is affected by the magnetic field. Also it can reach the same aim by change the position of the EUT.

#### 14.6.Test Results

**PASS.**

Please refer to the following page.

## Magnetic Field Immunity Test Result

EMTEK (SHENZHEN) CO., LTD.

Standard	IEC 61000-4-8			Result: <input checked="" type="checkbox"/> Pass / <input type="checkbox"/> Fail
Applicant : <u>MAGNIZON POWER SYSTEMS FZE</u> EUT : <u>Big power inverter</u> M/N: <u>APS-2012SW-LCD</u> Input Voltage : <u>AC 230/50Hz</u> Date of Test : <u>June 13, 2015</u> Test Engineer: <u>TZH</u> Ambient Condition : Temp : <u>22°C</u> Humid: <u>58%</u> Actual Criterion : A				
Operation Mode : Line mode				
Test Level (A/M)	Testing Duration	Coil Orientation	Criterion	Result
10	5 mins	X	A	A
10	5 mins	Y	A	A
10	5 mins	Z	A	A
Operation Mode : N/A				
Test Level (A/M)	Testing Duration	Coil Orientation	Criterion	Result
/	/	/	/	/
/	/	/	/	/
Test Equipment	Magnetic Field Test : HEAFELY MAG 100.1			
Note: /				

## 15. LOW FREQUENCY SIGNALS TEST

### 15.1. Block Diagram of Test Setup

#### 15.1.1. Block Diagram of the EUT

For Normal:

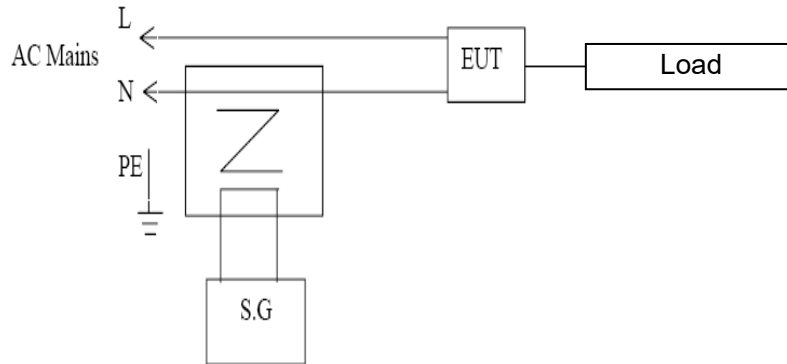

(EUT: Big power inverter)

### 15.2. Test Standard

IEC 61000-2-2:2002, Performance: A

	Criterion A
External and internal indications and metering (LCD)	No change
Output characteristics (Load)	No change
Control signals to external devices (Signal line)	No change
Mode of operation	No change

### 15.3. Operating Condition of EUT

Same as Section 4.4, Except the test setup replaced by Section 15.1.

### 15.4. Test Results

**PASS.**

Please refer to following pages.

## Low Frequency Signals Test Result

EMTEK (SHENZHEN) CO., LTD.

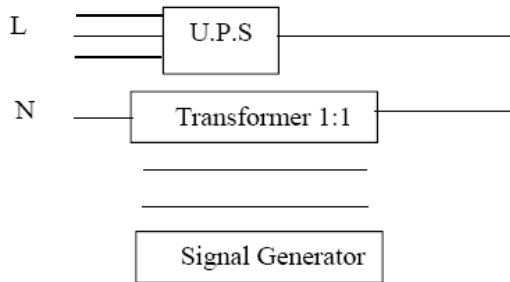
Applicant: <u>MAGNIZON POWER SYSTEMS FZE</u> EUT : <u>Big power inverter</u> M/N : <u>APS-2012SW-LCD</u> Power Supply : <u>AC 230/50Hz</u> Test Engineer : <u>TZH</u>				Test Date: <u>June 13, 2015</u> Temperature : <u>22°C</u> Humidity : <u>50%</u> Test Mode : <u>Line mode</u> Actual Criterion : <u>A</u>	
Frequency Range (Hz)	Step (Hz)	Position	Strength	Result	Note
140	10	See Fig.1	10V(rms) Sinusoidal	P	A
160				P	A
200				P	A
240				P	A
280				P	A
320				P	A
360				P	A
Note: This result for normal.  			Test Equipment: 1. Isolation transformer Primary: Secondary=1:1 2. Signal Generator AC Source: 65930 (Chroma)		

## 16. TEST PHOTOGRAPH

### 16.1.Photos of Conducted Emission Measurement



16.2. Photo of Radiation Emission Measurement

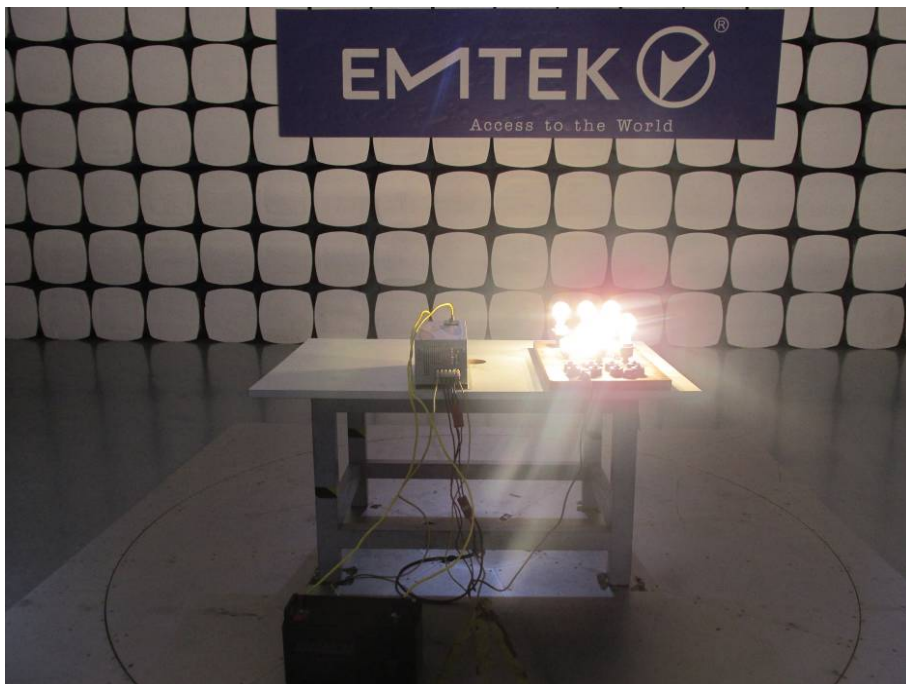
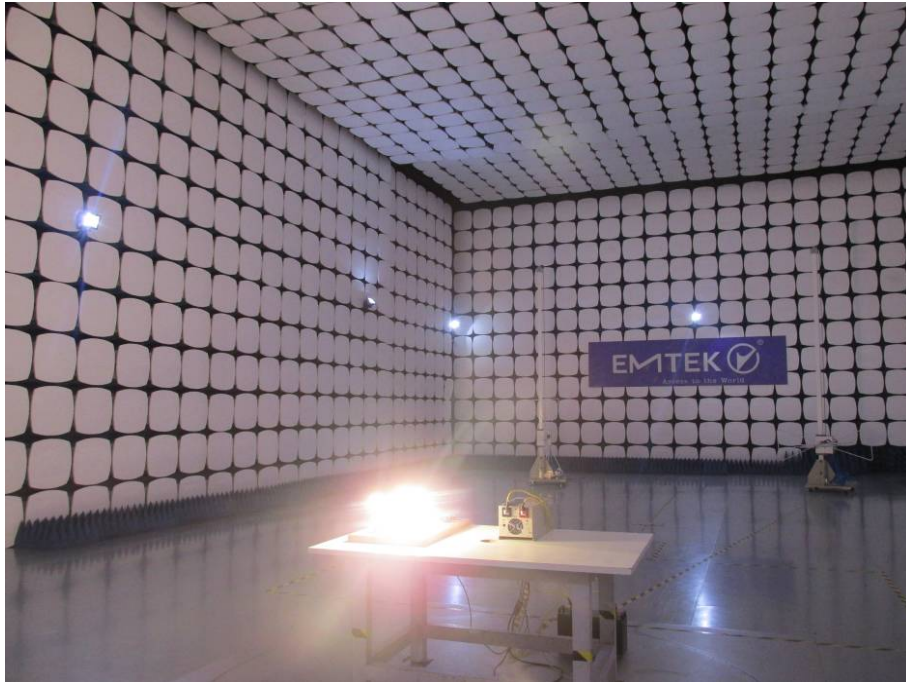

### 16.3. Photo of Harmonic Measurement



### 16.4. Photo of Electrostatic Discharge Test





16.5. Photo of RF Field Strength susceptibility Test



16.6. Photos of Electrical Fast Transient /Burst Test



16.7.Photo of Surge Test



16.8.Photo of Injected Currents Susceptibility Test

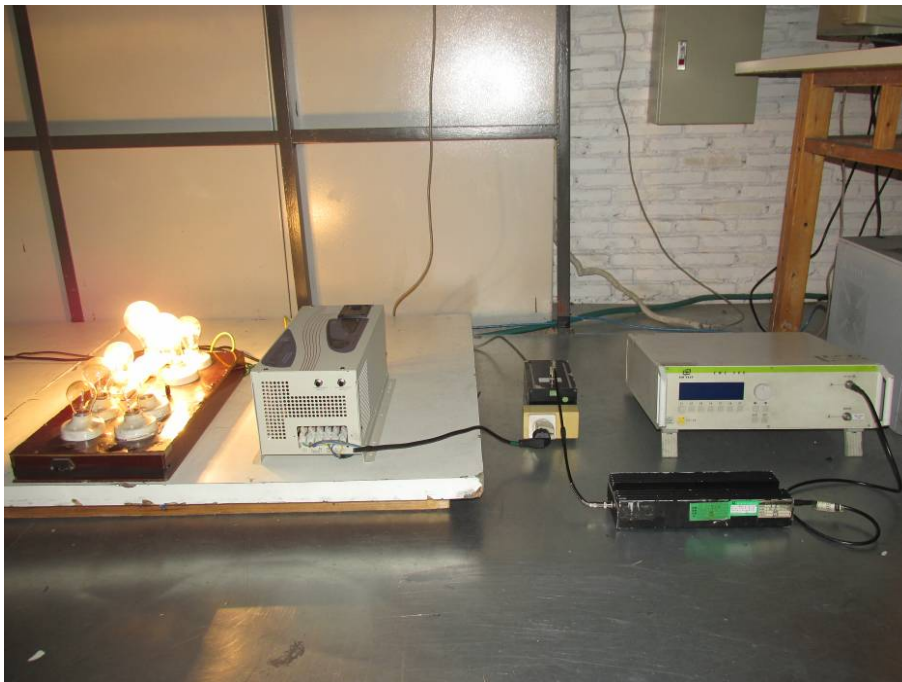

16.9. Photo of Magnetic Field Immunity Test

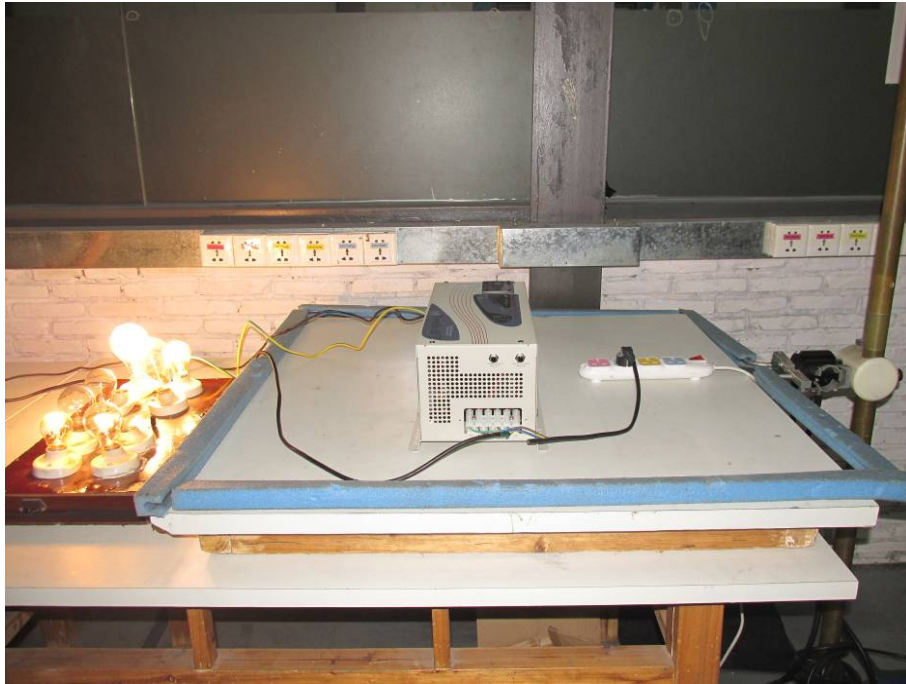

16.10. Photo of Low Frequency Signals Test



## APPENDIX (Photos of EUT)





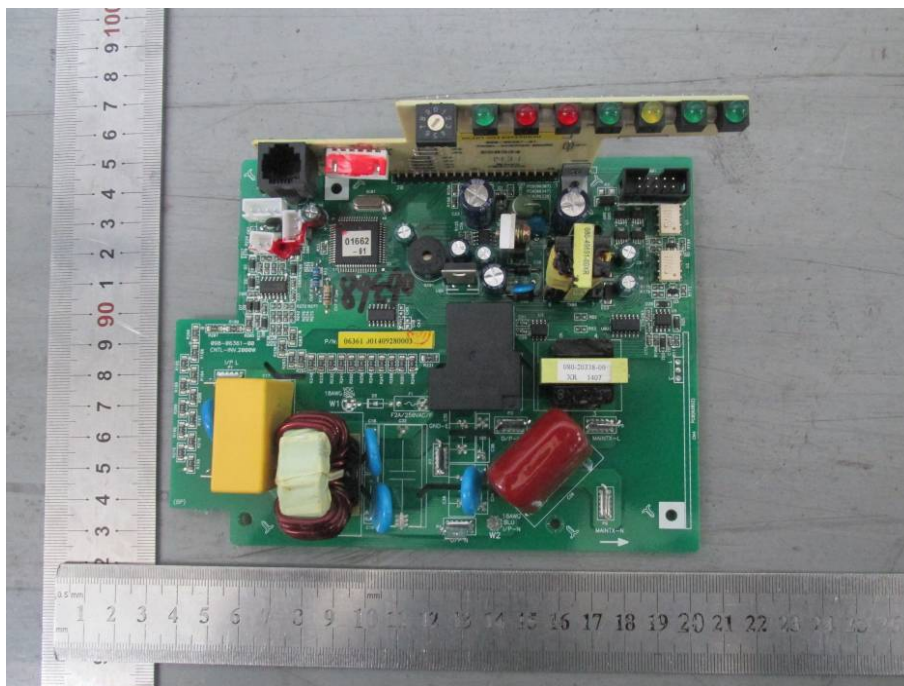
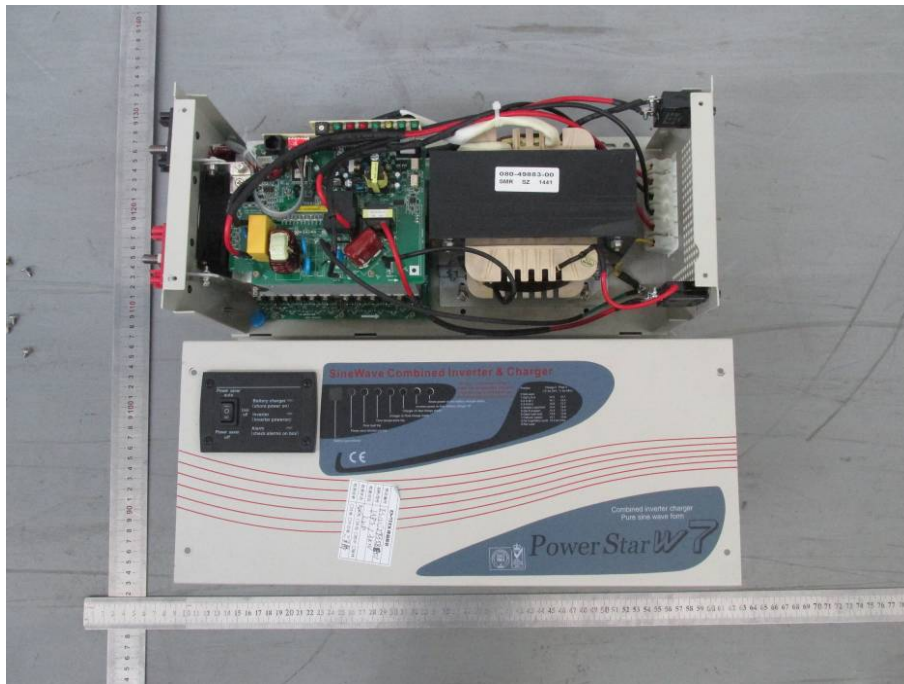

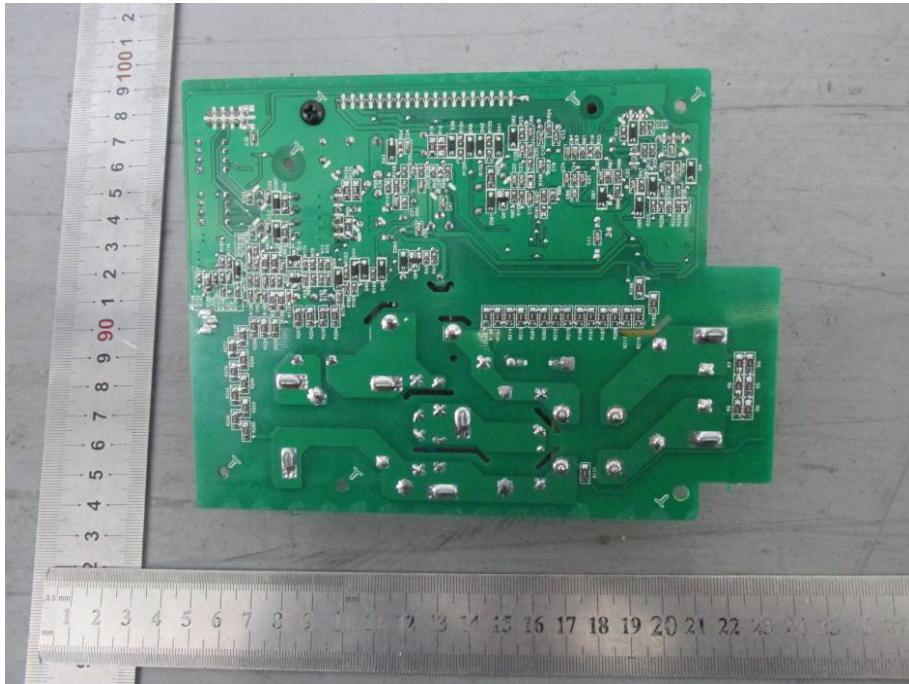

-----The end-----